



PROFX10GO

10-CHANNEL BATTERY POWERED ANALOG MIXER
WITH ENHANCED FX, USB RECORDING MODES, AND BLUETOOTH

OWNER'S MANUAL



Important Safety Instructions

1. Read these instructions.
2. Keep these instructions.
3. Heed all warnings.
4. Follow all instructions.
5. Do not use this apparatus near water.
6. Clean only with a dry cloth.
7. Do not block any ventilation openings. Install in accordance with the manufacturer's instructions.
8. Minimum distance (5 cm) around the apparatus for sufficient ventilation. The ventilation should not be impeded by covering the ventilation openings with items, such as newspapers, table-cloths, curtains, etc.
9. Do not install near any heat sources such as radiators, heat registers, stoves, or other apparatus (including amplifiers) that produce heat.
10. No naked flame sources, such as lighted candles, should be placed on the apparatus.
11. Do not defeat the safety purpose of the polarized or grounding-type plug. A polarized plug has two blades with one wider than the other. A grounding-type plug has two blades and a third grounding prong. The wide blade or the third prong are provided for your safety. If the provided plug does not fit into your outlet, consult an electrician for replacement of the obsolete outlet.
12. Protect the power cord from being walked on or pinched particularly at plugs, convenience receptacles, and the point where they exit from the apparatus.
13. Only use attachments/accessories specified by the manufacturer.
14. Use only with a cart, stand, tripod, bracket, or table specified by the manufacturer, or sold with the apparatus. When a cart is used, use caution when moving the cart/apparatus combination to avoid injury from tip-over.
15. Unplug this apparatus during lightning storms or when unused for long periods of time.
16. Refer all servicing to qualified service personnel. Servicing is required when the apparatus has been damaged in any way, such as power-supply cord or plug is damaged, liquid has been spilled or objects have fallen into the apparatus, the apparatus has been exposed to rain or moisture, does not operate normally, or has been dropped.
17. This apparatus shall not be exposed to dripping or splashing, and no object filled with liquids, such as vases or beer glasses, shall be placed on the apparatus.
18. Do not overload wall outlets and extension cords as this can result in a risk of fire or electric shock.
19.  This apparatus has been designed with Class-I construction and must be connected to a mains socket outlet with a protective earthing connection (the third grounding prong).



20. This apparatus has been equipped with a rocker-style AC mains power switch. This switch is located on the rear panel and should remain readily accessible to the user.
21. The MAINS plug or an appliance coupler is used as the disconnect device, so the disconnect device shall remain readily operable.
22. The use of apparatus is in moderate climates.
23. This equipment complies with FCC and ICSED radiation exposure limits set forth for an uncontrolled environment. This equipment should be installed and operated with minimum distance 20cm between the radiator & your body. The product can be sold in all EU countries. Bluetooth transmitter frequency range: 2.402 – 2.480 GHz
24. **NOTE:** This equipment has been tested and found to comply with the limits for a Class B digital device, pursuant to part 15 of the FCC Rules. These limits are designed to provide reasonable protection against harmful interference in a residential installation. This equipment generates, uses, and can radiate radio frequency energy and, if not installed and used in accordance with the instructions, may cause harmful interference to radio communications.

If this equipment does cause harmful interference to radio or television reception, which can be determined by turning the equipment off and on, the user is encouraged to try to correct the interference by one or more of the following measures:

- Reorient or relocate the receiving antenna.
- Increase the separation between the equipment and the receiver.
- Connect the equipment into an outlet on a circuit different from that to which the receiver is connected.
- Consult the dealer or an experienced radio/TV technician for help.

CAUTION: Changes or modifications to this device not expressly approved by LOUD Audio, LLC. could void the user's authority to operate the equipment under FCC rules.

This device complies with Part 15 of the FCC Rules [and contains license-exempt transmitter(s)/receiver(s) that comply with Innovation, Science and Economic Development Canada's license-exempt RSS(s)]. Operation is subject to the following two conditions:

- (1) This device may not cause harmful interference, and
- (2) This device must accept any interference received, including interference that may cause undesired operation.

25. This apparatus does not exceed the Class B limits for radio noise emissions from digital apparatus as set out in the radio interference regulations of the Innovation, Science and Economic Development Canada. CAN ICES-003(B)/NMB-003(B)

ATTENTION — *Le présent appareil numérique n'émet pas de bruits radioélectriques dépassant les limites applicables aux appareils numériques de class A/de class B (selon le cas) prescrites dans le règlement sur le brouillage radioélectrique édicté par les ministere d'Innovation, Sciences et Développement économique Canada.*

26. Exposure to extremely high noise levels may cause permanent hearing loss. Individuals vary considerably in susceptibility to noise-induced hearing loss, but nearly everyone will lose some hearing if exposed to sufficiently intense noise for a period of time. The U.S. Government's Occupational Safety and Health Administration (OSHA) has specified the permissible noise level exposures shown in the following chart.

According to OSHA, any exposure in excess of these permissible limits could result in some hearing loss. To ensure against potentially dangerous exposure to high sound pressure levels, it is recommended that all persons exposed to equipment capable of producing high sound pressure levels use hearing protectors while the equipment is in operation. Ear plugs or protectors in the ear canals or over the ears must be worn when operating the equipment in order to prevent permanent hearing loss if exposure is in excess of the limits set forth here:

Duration, per day in hours	Sound Level dBA, Slow Response	Typical Example
8	90	Duo in small club
6	92	
4	95	Subway Train
3	97	
2	100	Very loud classical music
1.5	102	
1	105	Chaz screaming at Troy about deadlines
0.5	110	
0.25 or less	115	Loudest parts at a rock concert





CAUTION

RISK OF ELECTRIC SHOCK! DO NOT OPEN!



CAUTION: TO REDUCE THE RISK OF ELECTRIC SHOCK DO NOT REMOVE COVER (OR BACK). NO USER-SERVICEABLE PARTS INSIDE. REFER SERVICING TO QUALIFIED PERSONNEL.

 The lightning flash with arrowhead symbol within an equilateral triangle is intended to alert the user to the presence of uninsulated "dangerous voltage" within the product's enclosure, that may be of significant magnitude to constitute a risk of electric shock to persons.

 The exclamation point within an equilateral triangle is intended to alert the user of the presence of important operating and maintaining (servicing) instructions in the literature accompanying the appliance.

WARNING — The battery (battery or batteries or battery pack) shall not be exposed to excessive heat such as sunshine, fire or the like.

CAUTION — Danger of explosion if battery is incorrectly replaced. Replace only with the same or equivalent type.

CAUTION — A battery subjected to extremely low air pressure may result in an explosion or the leakage of flammable liquid or gas.

WARNING — To reduce the risk of fire or electric shock, do not expose this apparatus to rain or moisture.



Correct disposal of this product: This symbol indicates that this product should not be disposed of with your household waste, according to the WEEE directive (2012/19/EU) and your national law. This product should be handed over to an authorized collection site for recycling waste electrical and electronic equipment (EEE). Improper handling of this type of waste could have a possible negative impact on the environment and human health due to potentially hazardous substances that are generally associated with EEE. At the same time, your cooperation in the correct disposal of this product will contribute to the effective usage of natural resources. For more information about where you can drop off your waste equipment for recycling, please contact your local city office, waste authority, or your household waste disposal service.

Table of Contents

Important Safety Instructions.....2

Table of Contents3

Chapter 1 : Welcome.....6

Introduction.....6
Features6
Things to Remember7
About This Guide8
Getting Started.....8

Chapter 2 : ProFX10 GO Rear Panel Features9

Introduction.....9
Power Connector9
Power Switch.....9
USB-C Computer Jack.....10

Chapter 3 : ProFX10 GO Top Panel Features11

Introduction.....11
XLR and 1/4" Combo Input Jacks11
XLR Mic Input Jacks.....12
1/4" Line Input Jacks12
1/4" Stereo Line Input Jacks12
1/8" Stereo Line Input Jack.....13
Line / Hi-Z Switches [Chs. 1 and 2].....13
Low Cut Switches13
1/4" Insert Jacks14
Gain Knobs and Level Set LEDs15
Compressor Knobs.....16
Channel Equalization (EQ)17
FX Knobs18

Pan Knobs	18
Mute Switches	18
Channel Level Knobs	19
USB 3-4 Switch	19
Bluetooth Switch	19
FX Footswitch Jack	20
L/R Main Output Jacks	20
1/4" Headphone Output Jack	21
1/4" Control Room Jacks	22
1/4" FX Send Jack	22
48V Phantom Power Switch	22
Power LED	22
Main Meters	23
FX Master Level Knob	23
FX Mute Switch	23
To Phones / Control Room Switch	23
Control Room Knob	23
Phones Knob	24
Blend Knob	24
Main Mix Level Knob	24
Main Mute Switch	24
GIGFX+ Effects Engine	25
Preset Display	25
Studio Command Control Knob	25
Back Button	25
Factory Reset	25
FX Section	26
Delay	27
FX EQ	28
Delay Parameters and Values	29
Echo Parameters and Values	29
Slapback Parameters and Values	29
FX Presets	30
FX EQ Reset	31
Hall Reverb Parameters and Values	32
Room Reverb Parameters and Values	32
Plate Reverb Parameters and Values	32
Chorus 1 Parameters and Values	33
Chorus 2 Parameters and Values	33
Flanger Parameters and Values	34
Delay + Reverb Parameters and Values	35
Delay + Chorus Parameters and Values	35
Reverb + Chorus Parameters and Values	36
Outdoors	36
Recording Mode	38
Battery Replacement	38

Hookup Diagrams 40

Hookup Diagrams > Typical Live Sound System 40
Hookup Diagrams > Typical Recording System..... 41
Hookup Diagrams > Camping..... 42

Appendix A : Service Information..... 43

Troubleshooting..... 43
Microphone Stand 45
Repair 45

Appendix B : Technical Information 46

Specifications 46
ProFX10 GO Dimensions 49
ProFX10 GO Block Diagram 50
ProFX10 GO Track Sheet 51

Appendix C : USB 3/4 Return Setup..... 52

Introduction..... 52
Windows 52
Mac 52

Warranty Statement 53

Fin 54

Chapter 1 : Welcome

Introduction

Hello everyone! This is the ProFXIO GO Owner's Manual. This document contains detailed information about the ProFXIO GO... we hope you like it!

Mackie ProFXIO GO is a professional analog mixer and USB-C audio interface that can run on a rechargeable, swappable battery for up to 8 hours, so you're always ready to mix on the GO. Unplug and never miss a beat.

Take advantage of the incredibly low-noise, high-headroom performance of award-winning Onyx™ preamps, tone-shaping EQ, analog compression, GigFX+™ effects and three USB recording modes.

Connect your phone via Bluetooth® to play music, perform over backing tracks or do a live stream.

ProFXIO GO gives you the zero-compromise Mackie analog mixing experience you need for any remote gig or high-stakes event.

If you have any questions or comments about this Owner's Manual (or other Mackie documentation), please don't hesitate to contact us:

- 1-800-898-3211 (Monday through Friday, normal business hours, Pacific Time)
- www.mackie.com/support-contact

Features

SWAPPABLE, RECHARGEABLE GB-10 BATTERY

- Includes GB-10 rechargeable battery for up to 8 hours of mixing and recording, miles from a power outlet
- The battery recharges whenever the mixer is plugged into power, or you can recharge it outside the unit, so it's always good to GO
- Battery also serves as an excellent backup when you are short on power outlets, or working a shady venue with questionable power
- When you're out of juice, swap out the battery with a spare (sold separately) for double the battery life
- All the bells and whistles of a professional Mackie mixer, including Onyx™ preamps, no longer chained to the wall
- A new level of premium battery-powered mixing for mobile DJs, remote event producers or venues with limited power

BI-DIRECTIONAL BLUETOOTH®

- Connect your phone or tablet via the dedicated Bluetooth® channel
- Send and receive audio wirelessly
- Play songs or perform over backing tracks
- Stream your gig or event live on Twitch, YouTube or Instagram with your phone
- Mix Minus lets you take phone calls through the mixer without the caller hearing themselves

CUSTOMIZABLE GIGFX+ EFFECTS

- High-resolution GigFX+™ effects engine includes reverbs, delays, choruses and more
- Full-color LCD display for editing and saving effects presets

USB RECORDING MODES

- 24-bit / 192 kHz 2x4 USB-C audio interface
- Three USB recording modes: Standard (include FX), Loopback (include computer audio) and Interface (channels 1-2 dry)
- Dedicated USB 1-2 playback with blend control for monitoring computer output and a latency-free feed from the mixer
- Separate USB 3-4 return on channel 7/8, perfect for playing software instruments and overdubbing
- Waveform OEM™ recording software included

ANALOG MIXING ESSENTIALS

- 4 Onyx™ mic preamps with up to 60 dB of gain on channels 1-4
- Hi-Z switches on channels 1 and 2 for direct connection of instruments
- 100 Hz low-cut filters
- 3-band EQ on all channels
- One-knob compression on channels 1 and 2

VERSATILE CONNECTIVITY

- XLR/TRS combo inputs on channels 1 and 2
- Separate XLR and TRS inputs on channels 3 and 4
- TRS channel inserts on channels 1-4
- Stereo 1/4" TRS line inputs on channels 5/6 and 7/8
- Stereo 1/8" line input on channel 9/10
- 1/4" footswitch input
- 1/4" TRS control room outputs for powered speakers
- 1/4" headphone output with independent level control
- Stereo XLR and 1/4" TRS main outputs
- 1/4" TRS output for aux send

PHYSICAL SPECS

- Legendary Built-Like-A-Tank construction
- Solid steel chassis
- Tough ABS side protection
- 5.9 lb / 2.7 kg with battery (light enough to carry)
- 3.8 x 10.5 x 11.8 in / 97 x 267 x 300 mm (fits in a backpack)

Things to Remember

- Never listen to loud music for prolonged periods.
Please see the Safety Instructions on page 2 for information on hearing protection.
- As a general guide, the ProFXIO GO should be turned on first, subwoofers next, and the loudspeakers last. As such, the loudspeakers should also be turned off first, followed by the subwoofers, then the ProFXIO GO. This will reduce the possibility of any turn-on or turn-off thumps and other noises generated by any upstream equipment from coming out of the speakers.
- Save the shipping boxes and packing materials! You may need them someday. Besides, the cats will love playing in them and jumping out at you unexpectedly. Remember to pretend like you are surprised!
- Save your sales receipt in a safe place.

About This Guide

This guide is designed to be accessible, with subsections as complete as practical to minimize having to electronically leaf back and forth looking for the whole story. The entire guide does not need to be read to figure out how to use this console.

As the saying goes, “a picture tells a 1000 words”. With that thought in mind, we added quite a few illustrations, screenshots and other images throughout to accompany the text.



This icon marks information that is critically important or unique! For your own good, read and remember them.



There's an illustration of a microscope, so, of course, you're going to get more detailed information when you see this little guy. There are explanations of features and practical tips listed here.



It's a good idea to pay attention to text displayed next to a note icon, as this icon draws attention to certain features and functions relating to the usage of ProFXIO GO.

Getting Started

The following steps will help you set up the ProFXIO GO quickly. If you desire a more thorough walk-through of ProFXIO GO, there is a wealth of information in the following pages!

1. Read and understand the Important Safety Instructions on page 2.
2. Turn down all knobs except the channel EQ and pan knobs.
3. Set all channel EQ knobs and pan knobs at their center detent.
4. Disengage all switches.
5. Connect cords from the main outs to powered speakers (or to an amplifier connected to passive speakers).
6. Push the line cord securely into the mixer's connector and plug the other end into a grounded AC outlet. The mixer may accept the appropriate voltage as indicated near the connector.
7. Turn the mixer on.
8. Turn the powered speakers (or amplifiers) on.
9. Plug signal sources into the mixer, such as:
 - Microphones plugged into the mic inputs. (Engage phantom power if needed.)
 - Instrument level sources, such as acoustic guitars w/active pickups into the instrument inputs
 - Line-level sources such as keyboards, drum machines, or CD players plugged into the line-level inputs.
 - Smartphone paired and connected via Bluetooth.
10. Be sure that the volume of the input is the same as it would be during normal use.
11. Turn up that channel's fader to the “U” (unity gain) position.
12. Slowly bring up the main fader to a comfortable listening level.
13. Repeat steps 9 to 11 for the other channels.

Chapter 2 : ProFX10 GO Rear Panel Features



Introduction

The top panel of the ProFX10 GO mixer may be where the magic all happens, but nothing will happen if it can't be powered up, so let's start there! The rear panel of each ProFX10 GO mixer is outfitted with a power connector, power switch, and a USB-C port for connecting to a computer. Let's take a look at each of these features, starting with the power connector and power switch, followed by a look at the USB-C port.

Power Connector

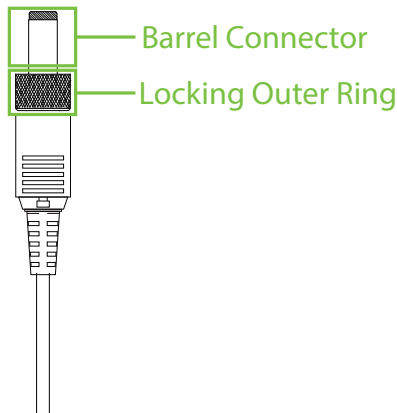

Each ProFX10 GO mixer has a universal external power supply that accepts any AC voltage ranging from 100 VAC to 240 VAC. No need for voltage select switches. It will work virtually anywhere in the world. That's why we call it a "Planet Earth" power supply! It is less susceptible to voltage sags or spikes compared to conventional power supplies, and provides greater electromagnetic isolation and better protection against AC line noise.

A locking barrel connector resides at one end of the cord attached to the power supply adapter (aka "wall wart"). Attach it to the power connector on the ProFX10 GO mixer and rotate the outer ring clockwise to lock. Do not over-tighten! Screw until there is resistance, then stop. Connect the other end of the power supply adapter into a grounded AC outlet.



Only use the factory-authorized power supply that came with the ProFX10 GO.

Power Switch

Located next to the power connector is the power switch. Press the top of this rocker switch in to turn the ProFX10 GO mixer on and press the bottom of this switch in to turn it off.

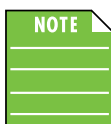

As a general guide, the ProFX10 GO should be turned on first, followed by external power amplifiers or powered speakers. As such, the ProFX10 GO should also be turned off last. This will reduce the possibility of any turn-on or turn-off thumps in the PA.

USB-C Computer Jack

This is a 2x4 interface that allows audio to stream to and from the ProFXIO GO mixer via computer. Connect the USB-C side of a USB cable to the ProFXIO GO mixer and the USB-A side to the computer's USB port.



Don't forget to change the input and output to 'ProFXIO GO' via Settings on your computer.



The ProFXIO GO's USB connection is audio only. It is not a source of power.

Chapter 3 : ProFXIO GO Top Panel Features

Introduction

From top to bottom and left to right, the top panel of each ProFXIO GO mixer is outfitted with a bunch of knobs, buttons, faders, jacks, screens, and more. So much more, in fact, that we will call out and describe each one...

XLR and 1/4" Combo Input Jacks



The first two input channels may accept a balanced mic or line-level signal using an XLR connector. They are wired as follows, according to standards specified by the AES (Audio Engineering Society).

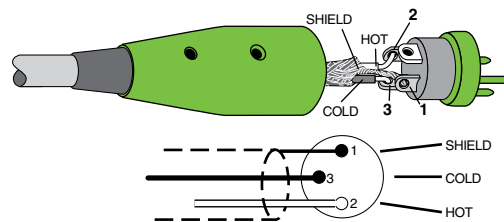

XLR Balanced Wiring:

- Pin 1 = Shield (ground)
- Pin 2 = Positive (+ or hot)
- Pin 3 = Negative (- or cold)

In addition to accepting balanced mic or line-level signals using an XLR connector, these inputs may also accept 1/4" line-level signals driven by balanced or unbalanced sources.

To connect balanced lines to these inputs, use a 1/4" Tip-Ring-Sleeve (TRS) plug. "TRS" stands for Tip-Ring-Sleeve, the three connection points available on a stereo 1/4" or balanced phone jack or plug. TRS jacks and plugs are used for balanced signals and stereo headphones and are wired as follows:

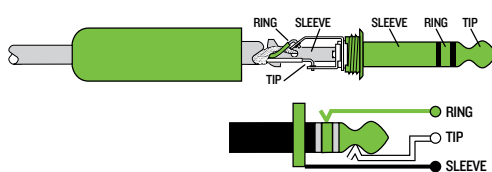

1/4" TRS Balanced Mono Wiring:

- Sleeve = Shield
- Tip = Hot (+)
- Ring = Cold (-)

To connect unbalanced lines to these inputs, use a 1/4" mono (TS) phone plug, wired as follows:

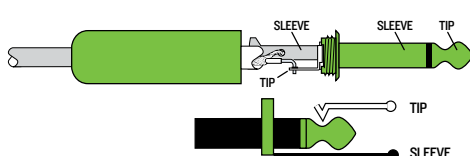

1/4" TS Unbalanced Mono Wiring:

- Sleeve = Shield
- Tip = Hot (+)

XLR Mic Input Jacks



This is a female XLR connector that accepts a balanced mic or line level input from almost any type of source. These mic preamps feature higher fidelity and headroom rivaling any standalone mic preamp on the market today. These circuits are excellent at rejecting hum and noise.

Professional ribbon, dynamic, and condenser mics all sound excellent through these inputs. The mic / line inputs will handle any kind of level you can toss at them, without overloading. The wiring diagrams are presented on the previous page.



NEVER connect the output of an amplifier directly to a ProFXIO GO mixer's input jack. This could damage the input circuitry and we wouldn't want that now, would we?

1/4" Line Input Jacks



These 1/4" jacks share circuitry (but not phantom power) with the mic preamps, and can be driven by balanced or unbalanced sources at almost any level. You can use these inputs for virtually any signal you'll come across.

To connect balanced lines to these outputs, use a 1/4" Tip-Ring-Sleeve (TRS) plug. "TRS" stands for Tip-Ring-Sleeve, the three connection points available on a stereo 1/4" or balanced phone jack or plug. The wiring diagrams are presented on the previous page.



NEVER connect the output of an amplifier directly to a ProFXIO GO mixer's input jack. This could damage the input circuitry and we wouldn't want that now, would we?

1/4" Stereo Line Input Jacks



The stereo line inputs are designed for 1/4" TRS balanced or 1/4" TS unbalanced signals. They may accept any line-level instrument, effects device, CD player, etc.

If you are connecting a mono source, use the left (mono) input, and the mono signals will appear on both sides of the main mix.

To connect balanced lines to these inputs, use a 1/4" Tip-Ring-Sleeve (TRS) plug. To connect unbalanced lines to these inputs, use a 1/4" mono (TS) phone plug. The wiring diagrams are presented on the previous page.



NEVER connect the output of an amplifier directly to a ProFXIO GO mixer's input jack. This could damage the input circuitry and we wouldn't want that now, would we?

1/8" Stereo Line Input Jack

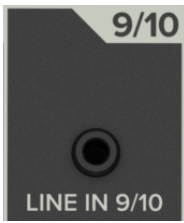

This 1/8" stereo input may accept a stereo or mono line-level signal from a smartphone, tablet, MP3 player, CD player or other signal source.

It is wired as follows, according to standards specified by the AES (Audio Engineering Society):

Stereo 1/8" TRS

Sleeve = Shield (Ground)

Tip = Left Channel

Ring = Right Channel

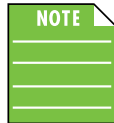

While the volume may be raised and lowered via the ProFXIO GO mixer, the volume of the device also needs to be up.

Line / Hi-Z Switches [Chs. 1 and 2]



To connect a guitar or bass directly to the mixer without using a DI Box, press this switch in first; then connect the output from the instrument to the channel's 1/4" TRS input. The input impedance is optimized for direct connection and high-frequency fidelity is assured.

In the out position, the channel's 1/4" TRS input becomes a line input just like the other mono line inputs.

To use guitars or other instruments on other channels, you will need to use an external DI box first. Without the DI box – or if this switch is not pressed in – guitars may sound dull and muddy.

Low Cut Switches

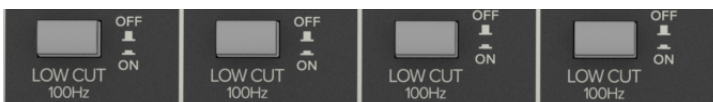

All channels with a mic input have a low-cut switch (often referred to as a high-pass filter) that cuts bass frequencies below 100 Hz at a rate of 18 dB per octave.

We recommend that you use low-cut on every microphone application except kick drum, bass guitar, or bassy synth patches. These aside, there isn't much down there that you want to hear, and filtering it out makes the low stuff you do want much more crisp and tasty. Not only that, but low-cut can help reduce the possibility of feedback in live situations, and it helps to conserve amplifier power.



Another way to consider low-cut's function is that it actually adds flexibility during live performances. With the addition of low-cut, you can safely use low equalization on vocals. Many times, bass shelving EQ can really benefit voices. Trouble is, adding low EQ also boosts stage rumble, mic handling clunks and breath pops from way-down low. Applying low-cut removes all those problems, so you can add

low EQ without blowing the woofers.

1/4" Insert Jacks



These unbalanced 1/4" jacks are for connecting serial effects processors such as compressors, equalizers, de-essers, or filters.

The insert point is after the gain control and low cut filter, but before the channel's EQ and level. The channel signal can go out of the insert jack to an external device, be processed and come back in on the same insert jack.

To do this requires a standard insert cable that must be wired thusly:

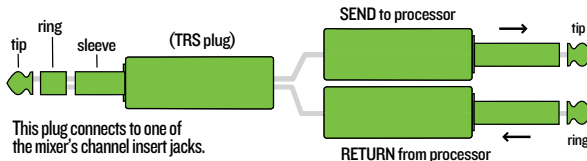

Tip = send (output to effects device)
 Ring = return (input from effects device)
 Sleeve = common ground

Insert jacks may be used as channel direct outputs; post-gain, and pre-EQ. If you insert a TS (mono) 1/4" plug only partially (to the first click) into an insert jack, the plug will not activate the jack switch and will not open the insert loop in the circuit (thereby allowing the channel signal to continue on its merry way through the mixer). This allows you to tap out the channel signal without interrupting normal operation.

If you push the 1/4" TS plug in to the second click, you will open the jack switch and create a direct out, which does interrupt the signal in that channel. See illustration below.



Do not overload or short-circuit the signal you are tapping from the mixer. That will affect the internal signal.

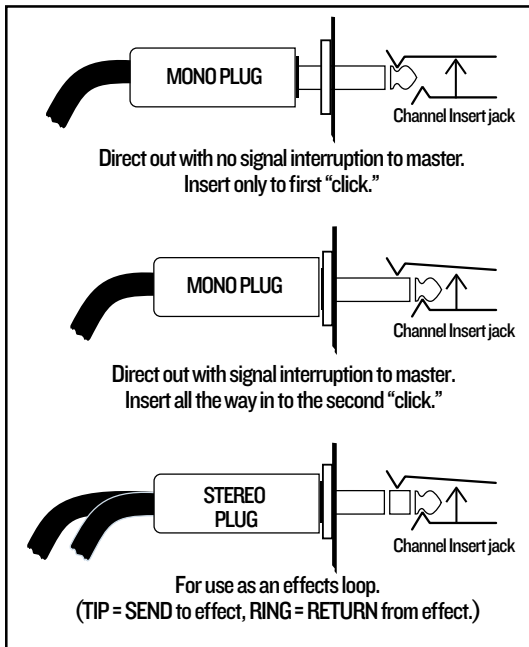

Gain Knobs and Level Set LEDs



“U” like Unity Gain

ProFXIO GO mixers have a “U” symbol on many level controls. It stands for “unity gain,” meaning no change in signal level. The labels on the controls are measured in decibels (dB), so you’ll know what you’re doing level-wise if you choose to change a control’s settings.

If you haven’t already, please read the “Getting Started” section on page 8. Setting the gain correctly will ensure that the preamplifier’s gain is not too high, where distortion could occur, and not too low, where the quieter, exquisitely-delicate passages might be lost in background noise.

The gain knobs – in conjunction with the level set LEDs – adjust the input sensitivity of the mic and line inputs. This allows signals from the outside world to be adjusted to run through each channel at optimal internal operating levels.

If the signal originates through the mic XLR jack, there will be 0 dB of gain with the knob fully down, ramping to 60 dB of gain fully up.

Through the 1/4” mono line inputs, there is -20 dB of attenuation fully down and 40 dB of gain fully up, with unity gain “U” at 12:00.

This 20 dB of attenuation can be very handy when you are inserting a hot signal, or when you want to add EQ gain, or both. Without this “virtual pad,” there is more chance of channel clipping.



Next to every gain knob – except the 1/8” stereo input gain knob – lies a level set LED. These LEDs are used with the gain control to set the channel preamplifier gain just right for each source. If one or more channels are distorting, check the level set LEDs. If they are on continuously, turn down the gain.

Compressor Knobs



Channels 1–2 of each ProFXIO GO mixer has an in-line compressor circuit with a variable threshold.

This is very useful for compression of vocals, and snare drums, for example, so you might consider connecting your vocal and drum mics to these channels, rather than one of the other channels.

When the incoming signal exceeds the threshold level set by this knob, the signal level is automatically compressed. This reduces the dynamic range and reduces the chance of distortion due to overloading the input signals.



Dynamic range is the difference in level between the quietest and loudest parts of a song. A compressor “squeezes” the dynamic range, resulting in an overall steadier, more constant volume level for the signal. It helps sources, such as vocals, “sit” properly in the mix; it is very useful for live sound.

The compression ratio is fixed at around 6:1, with a soft knee response. The threshold can be adjusted clockwise from off (no compression) to 0 dBu (max).

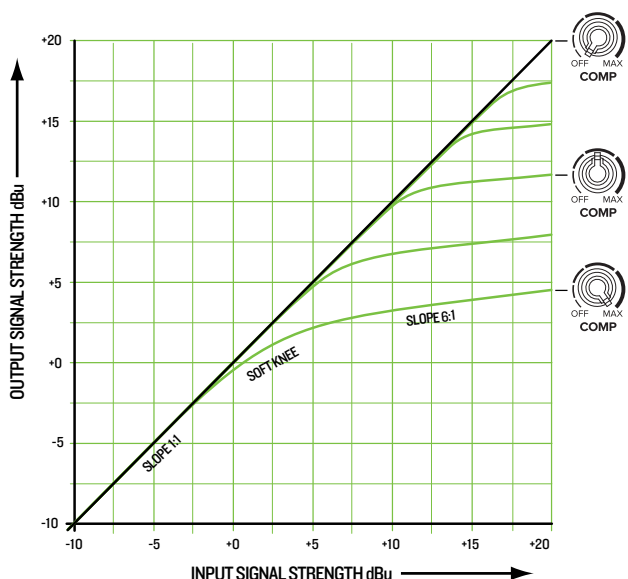

As an example, suppose the threshold is set to maximum. An incoming signal reaches the threshold of 0 dBu. As it increases beyond the threshold, it becomes compressed at a ratio of 6:1. This means that even if the input further increases by 6 dB, the actual output only increases by 1 dB. This compresses the output signal, so there is more protection to your system from distortion and overload due to poor microphone technique (say it ain’t so) and general pops, bangs and heavy metal screaming. The soft knee means that the compression slowly ramps up to 6:1 from the threshold. It does not jump abruptly to 6:1, as this would be hard knee compression, and harder on the ears too.

The graph to the left displays the input signal level going into the compressor, versus the output level coming out of it. It is the typical graph to view when compressors are discussed, and is just the kind of thing our engineers like to discuss during the company holiday party¹.

If the compressor is off, then the input = output. For example, an input signal level of +5 dBu results in an output level of +5 dBu. The diagonal line from lower left to upper right represents $x = y$, that is, input = output.

At the maximum compression, the threshold is set at 0 dBu, and the input to output relationship is represented by the lower curve. If the input is -5 dBu (that is, below the threshold), the output is -5 dBu. As the input reaches 0 dBu, the output is a bit less than 0 dBu. If the input is +5 dBu, the output is about +2 dBu. If the input reaches +10 dBu, then the output is +3 dBu. Notice the shapely curve of the soft knee between the diagonal slope of $x = y$ and the compressor slope of 6:1 (the compression ratio).

The other green curves represent in-between positions of the compressor knob, with higher thresholds before compression begins.

Outboard compressors often have controls such as compression ratio, threshold, soft knee/hard knee, attack time, and release time. These last two affect how quickly the compressor kicks in when the input exceeds the threshold, and how quickly it is released after it drops below the threshold. In this compressor, these parameters are specially chosen to give you the best overall performance.

Adjust the threshold carefully, so your dynamic range is still lovely, without distortion or overload during the performance. Run through a few practice screams and high-notes, and adjust the compression as required.

¹ My High School math teacher, Mr. Marvin, thought that graphs might come in handy for me one day. Finally!

Channel Equalization (EQ)



ProFX10 GO mixers have 3-band EQ with shelving hi, peaking mid, and shelving low. The 3-band equalization has low shelving at 80 Hz, mid peaking at 2.5 kHz, and high shelving at 12 kHz.

Shelving means that the circuitry boosts or cuts all frequencies past the specified frequency. For example, the low EQ boosts bass frequencies below 80 Hz and continuing down to the lowest note you never heard. Peaking means that certain frequencies form a “hill” around the center frequency.



With too much EQ, you can really upset things. We’ve designed a lot of boost and cut into each equalizer circuit because we know that everyone will occasionally need that. But if you max the EQ on every channel, you’ll get mix mush. Equalize subtly and use the left sides of the knobs (cut), as well as the right (boost). If you find yourself repeatedly using a lot of boost or cut, consider altering the sound source, such as placing a mic differently, trying a different kind of mic, a different vocalist, changing the strings, or gargling.

The EQ circuits are based upon the designs of Cal Perkins, an industry-leader in audio engineering for over four decades and a long-time collaborator. This “neo-classic” design provides the sweet musicality of the British EQ sound, while still maintaining 15 dB of boost and cut with optimum Q and minimum phase shift (in other words, it gives you plenty of control and is pleasing to the ear!).

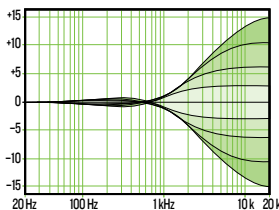

Hi EQ Knobs

The hi EQ provides up to 15 dB of boost or cut above 12 kHz, and it is also flat (no boost or cut) at the detent. Use it to add sizzle to cymbals, an overall sense of transparency, or an edge to keyboards, vocals, guitar and bacon frying. Turn it down a little to reduce sibilance or to mask tape hiss.

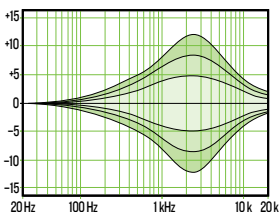

Mid EQ Knobs

Short for “midrange,” this knob provides up to 15 dB of boost or cut, centered at 2.5 kHz, also flat at the center detent. Midrange EQ is often thought of as the most dynamic, because the frequencies that define any particular sound are almost always found in this range. You can create many interesting and useful EQ changes by turning this knob down as well as up.

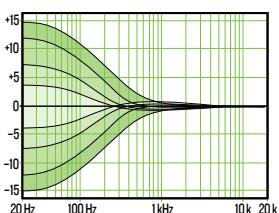

Low EQ Knobs

The low EQ provides up to 15 dB of boost or cut below 80 Hz. The circuit is flat at the center detent position. This frequency represents the punch in bass drums, bass guitar, fat synth patches, and some really serious male singers who eat raw beef for breakfast.

FX Knobs



These knobs tap a portion of each channel's signal to set up a nice FX mix feeding the internal FX processor, and to feed external processors via the FX send.

The controls are off when fully turned down, deliver unity gain at the center detent, and can provide up to 10 dB of gain turned fully up.

The mute, channel fader and other channel controls affect the FX output, but pan does not. The FX is post-fader.

The FX signal reaching the internal FX processor and the FX send output jack is the sum (mix) of all the channels whose FX control is set to more than minimum.

The overall output level may be adjusted with the master FX level knob.

Pan Knobs



This control allows you to adjust how much of the channel signal is sent to the left versus the right outputs.

The pan control employs a design called "Constant Loudness." If you have a channel panned hard left (or right) and then pan to the center, the signal is attenuated about 3 dB to maintain the same apparent loudness. Otherwise, it would make the sound appear much louder when panned center.

Mute Switches



Mute switches do just what they sound like they do. They turn off the signal by "routing" it into oblivion. Engaging a channel's mute switch (almost) provides the same results as turning the fader all the way down (a pre-aux send is not affected by the channel fader, but it is by the mute switch).

The channel insert will continue to provide a signal when a channel is muted. Mute switches illuminate red when engaged.

Channel Level Knobs



This is the last control in a channel's signal path, and it adjusts the level of each channel onto the main mix. The "U" mark indicates unity gain, meaning no increase or decrease of signal level. All the way up provides an additional 10 dB, should you need to boost a section of a song. If you find that the overall level is too quiet or too loud with the level near unity, check that the gain control is set correctly.

USB 3-4 Switch



When engaged, this switch overrides channels 7/8 and allows the USB return – stereo playback of Spotify® or a DAW via the USB connection, for example – to flow through the signal path instead. Like any other input, this signal may also be EQ'd or mixed in with the other signals and assigned to the main outs.



There is additional information about the USB 3/4 Return Switch, including setup help and other tips and tricks in Appendix C on page 52.

Bluetooth Switch



Mixers can only accept one input per channel and the ProFXIO GO is no different. This switch will engage the channel's pairing mode, allowing the mixer to be seen by other Bluetooth devices such as a phone or tablet.

If Bluetooth is disengaged, then the mixer will use the analog input signal. However, when connected via Bluetooth, then you have chosen to use the Bluetooth signal instead.

Pairing and Connecting – Press and hold the Bluetooth button for a few seconds to select it. The button will slow flash blue when selected. This is to indicate that the ProFXIO GO mixer and device are in pairing mode.

While the ProFXIO GO mixer is in pairing mode, simultaneously scan for Bluetooth devices on the phone or tablet. You should see ProFXIO GO appear in the "available devices" list. Select it. From there, the device should indicate that it is successfully connected. Additionally, the Bluetooth' button on the mixer will be solid instead of flashing.



A previously paired device will auto reconnect if both the device and mixer are powered on and in range.



The Bluetooth may disconnect when affected by Electrostatic Discharge [ESD]. Manually reconnect the Bluetooth connection.

FX Footswitch Jack



This 1/4" TRS connector is where to connect your favorite footswitch. This allows you to easily mute or un-mute the internal effects at will. Any one-button on/off footswitch will work. If the internal FX have already been muted with the internal FX mute switch, then the footswitch has no effect.

L/R Main Output Jacks



The main outputs provide a line-level signal that represents the end of the mixer chain, where the fully mixed stereo signal enters the real world. Connect these to the left and right inputs of your main power amplifiers, powered speakers, or serial effects processor (like a graphic equalizer or compressor/limiter).

The male XLR connectors provide a balanced line-level signal and is wired as follows, according to standards specified by the AES (Audio Engineering Society):

XLR Balanced Wiring:

- Pin 1 = Shield (ground)
- Pin 2 = Positive (+ or hot)
- Pin 3 = Negative (- or cold)

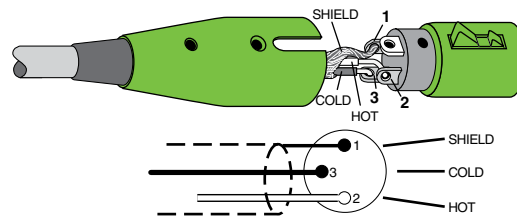

In addition to accepting balanced XLR connectors, the main outputs may also accept 1/4" connectors driven by balanced or unbalanced sources.

To connect balanced lines to these outputs, use a 1/4" Tip-Ring-Sleeve (TRS) plug. "TRS" stands for Tip-Ring-Sleeve, the three connection points available on a stereo 1/4" or balanced phone jack or plug. TRS jacks and plugs are used for balanced signals and are wired as follows:

1/4" TRS Balanced Mono Wiring:

- Sleeve = Shield
- Tip = Hot (+)
- Ring = Cold (-)

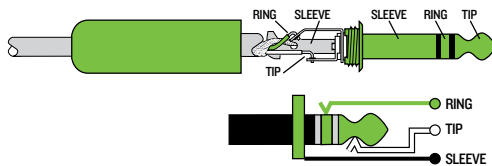

To connect unbalanced lines to these outputs, use a 1/4" mono (TS) phone plug, wired as follows:

1/4" TS Unbalanced Mono Wiring:

Sleeve = Shield
Tip = Hot (+)

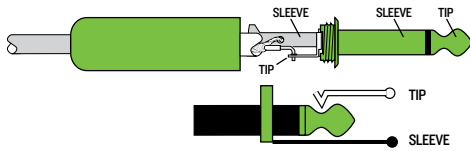

The XLR outputs are 6 dB hotter than the TRS outputs. When the meters read "0", the TRS outputs are at 0 dBu.

1/4" Headphone Output Jack



This 1/4" TRS connector supplies the output to stereo headphones. The volume is controlled via the phones knob.

The phones output follows standard conventions:

Tip = Left channel
Ring = Right channel
Sleeve = Ground

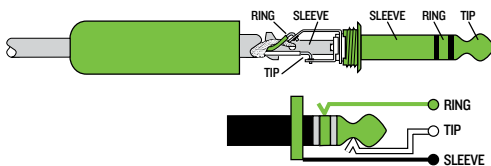

WARNING: The headphone amp is loud and can cause permanent hearing damage. Even intermediate levels may be painfully loud with some headphones. **BE CAREFUL!** Always turn the phones level control all the way down before connecting headphones or pressing a solo switch, or doing anything new that may affect the headphone volume. Then turn it up slowly as you listen carefully.



The signal leaving the phones jack may also accept a post-blend mix of the inputs and USB return if the "To Phones / Control Room" switch is engaged. More information about this switch (and the "Blend" knob) may be found on pages 23-24.

1/4" Control Room Jacks



These 1/4" jacks are usually patched to the inputs of a control room amplifier or a headphone distribution amplifier.

The control room outputs may also be used for other applications. The sound quality is just as impeccable as the main outputs. It may be used as an additional main mix output and this one will have its own level control.



The signal leaving the CR outs may also accept a post-blend mix of the inputs and USB return if the "To Phones / Control Room" switch is engaged. More information about this switch (and the "Blend" knob) may be found on pages 23-24.

1/4" FX Send Jack

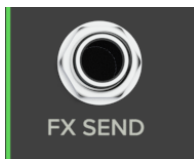

This 1/4" TRS line-level output may be used to feed an external effects processor (FX), such as a nice sound effect or delay unit. The output from this jack is an exact copy of what goes into the internal FX processor, being the careful mix of all channels whose aux FX control is turned to more than minimum.

(The processed output of the internal FX does not come out of this output, but is added internally to the main mix.)

The overall output level may be adjusted with the master FX knob. (This knob also affects the level going into the internal FX.)

The output is "post-fader," so any changes to the channel level knobs will also affect the level going to the external processor.

The processed output from the effects processor is usually returned to a spare channel, and you may carefully mix the original unprocessed channel (dry) and the processed channel (wet). Altering the original channel fader increases both the wet and dry signals and keeps them at the same delicate ratio. For example, the reverb remains at the same level relative to the original.

48V Phantom Power Switch



Most modern professional condenser mics require 48V phantom power which lets the mixer send low-current DC voltage to the mic's electronics through the same wires that carry audio. (Semi-pro condenser mics often have batteries to accomplish the same thing.) "Phantom" owes its name to an ability to be "unseen" by dynamic mics (Shure SM57/SM58, for instance), which don't need external power and aren't affected by it anyway.

Press this switch in if your microphone requires phantom power. (Always check the position of this switch before connecting microphones.) The accompanying LED will illuminate red to indicate that phantom power is active.

This is a global switch that affects all mic channels' XLR jacks at once.



Never plug single-ended (unbalanced) microphones, or ribbon mics into the mic input jacks if phantom power is on. Do not plug instrument outputs into the mic XLR input jacks with phantom power on unless you know for certain it is safe to do so. Be sure the main mix level knob is turned down when connecting microphones to the mic inputs when phantom power is turned on to prevent pops from getting through to the speakers.

Power LED

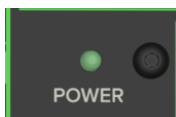

This LED will illuminate green when the mixer is turned on, as a reminder of how on it really is. If it is not on, then it is off, and the mixer becomes a rather nice weight for keeping your morning newspaper from blowing away in the wind.

If it does not turn on, make sure the power cord is correctly inserted at both ends, the local AC mains supply is active (and/or the battery is charged), and the power switch is on.

Main Meters



These peak meters are made up of two columns of twelve LEDs, with three colors to indicate different ranges of signal level, traffic light style. They range from -30 at the bottom, to 0 in the middle, to OL at the top.

You can get a good mix with peaks flashing anywhere between -20 and $+10$ dB on the meters. Most amplifiers clip at about $+10$ dBu, and some recorders aren't so forgiving either. For best real-world results, try to keep your peaks between "0" and "+6." Remember, audio meters are just tools to help assure you that your levels are "in the ballpark." You don't have to stare at them (unless you want to).

FX Master Level Knob



This knob provides overall control over the FX level just before they are delivered to the FX outputs. Stereo signals come through this FX knob and continue on to the main mix knob. They contain the effects' "wet" signals and are mixed together with the channels' "dry" original signals. Turned fully up, it provides 10 dB of additional gain, the "U" mark is unity gain, and fully down is off.

FX Mute Switch



When engaged, the internal effects processor is muted, and its output will not appear on the main mix. If this switch is not engaged, then the internal effects are set free and may be added as required to the main mix.

If this switch is not engaged, then the internal effects may be muted or un-muted with a footswitch.

To Phones / Control Room Switch

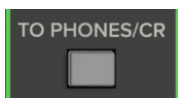

By default, the control room and phones jacks output the 2-track LR mix. Push this switch in if you want to interrupt this signal and hear the blended signals instead.

Control Room Knob



This knob is used to adjust the volume at the control room outputs, from ∞ (off) to maximum gain (max). Make sure that this knob is fully off [counter-clockwise] before selecting or adding a new source.

Phones Knob



This knob is used to adjust the volume at the phones output from ∞ (off) to maximum gain (max). Make sure that this knob is fully off [counter-clockwise] before selecting or adding a new source.



WARNING: The headphone amp is loud and can cause permanent hearing damage. Even intermediate levels may be painfully loud with some headphones. **BE CAREFUL!** Always turn the phones level control all the way down before connecting headphones or doing anything new that may affect the headphone volume. Then turn it up slowly as you listen carefully.

Blend Knob



With the adjacent (To Phones / Control Room) switch engaged, this knob sends a blend between all inputs (except for the 1/8" input) and the USB 1-2 Return to the Phones and Control Room outputs. As an added bonus, this is all at zero-latency!

Use this knob while recording overdubs alongside a pre-recorded track, for example.

Knob position (L, C, R):

- Full Left – Inputs = Full Volume
USB Return = No Volume
- Center – Inputs and USB Return = Equal Volume
- Full Right – Inputs = No Volume
USB Return = Full Volume

Main Mix Level Knob



This stereo knob allows you to adjust the levels of the main mix signals sent to the XLR and 1/4" main line-level outputs.

This gives you the ultimate feeling of power and control over the sound levels sent to your audience. Adjust this control carefully, with your good eye on the meters to check against overloading, and your good ear to the levels to make sure your audience (if any) is happy.

The main mix signals are off with the knob fully down, the "U" marking is unity gain, and fully up provides 10 dB of additional gain. This additional gain will typically never be needed, but once again, it's nice to know that it's there.

The knob is stereo, as it affects both the left and right of the main mix equally. This is the ideal control to slowly bring down at the end of a song (or quickly in the middle of a song if the need ever arises).

This control does not affect the FX send outputs.

Main Mute Switch



This important "take-a-break" switch quickly mutes all the microphones and line-level inputs to the main outs, cr outs and phones when the band is between sets. This will prevent protestors or rogue karaoke singers from storming the stage at the interval.

The FX send is not affected. If there is no sound coming out of the system, be sure to check this switch first.

It is located conveniently above the main mix level knob.

GIGFX+ Effects Engine



Preset Display

The Preset Display is one of the most vital features of the ProFX10 GO mixer. It displays information including (but not limited to) FX (and FX EQ), presets, and other parameters. Additional detail about all of these features may be found by continuing on.

Studio Command Control Knob

While the display presents the FX (and FX EQ), presets, and other parameters, it's the mixer's push-button rotary encoder that allows you to access these fields and change them.

Simply rotate the knob until the parameter you want to change is highlighted, push the encoder in, then make the changes. Again, additional details are coming soon. Please read on...

Back Button

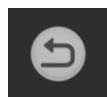

The back arrow button is used as a navigation tool to go back and forth between the FX list and the current effect.

Number	Effect
1	DELAY
2	ECHO
3	SLAPBACK
4	HALL REVERB
5	ROOM REVERB
6	PLATE REVERB
7	CHORUS 1
8	CHORUS 2
9	FLANGER
10	DELAY + REVERB
11	DELAY + CHORUS
12	REVERB + CHORUS

Pressing and holding the back button will display all 12 effects into two columns of six. From here, one is able to rotate the endless Studio Command Control Knob to select one of the 12 preset effects.

The fun thing about these preset effects is what was mentioned above... they may be updated and tweaked to your heart's content! More on this starting on the following page.

The different available effects presets are shown in the table to the left and the currently selected effect preset is shown in the display. Only one preset may be selected at a time. Further details of each preset is explained on the following pages.

Factory Reset

When a ProFX10 GO is factory reset, it restores most parameters back to their default. This includes all FX parameters and any stored presets. This is a permanent reset with no undo.

So how does one place the mixer back to its factory default? Press and hold the Studio Command Control Knob AND Back Button simultaneously until the display shows the Mackie Running Man.



Doing a factory reset and resetting the FX EQ (see page 31) are not the same thing and will result in different settings.

FX Section

The ProFXIO GO FX engine is incredibly powerful and packed with a ton of features.

There are 12 effects to choose from, but each one of those may be manipulated and tweaked to your inclination.

Before diving in, though, let's take a look at a table of the 12 effect types with a description of each preset and some examples.

Note that the effects are presented in four sets of three:

- Effects 1-3 – Delays – **Virtual Knob Color = blue**
- Effects 4-6 – Reverbs – **Virtual Knob Color = red**
- Effects 7-9 – Modulations – **Virtual Knob Color = purple**
- Effects 10-12 – Multi-purpose – **Virtual Knob Color = yellow**

Number	Title	Description	Example of its use
1	Delay	This effect repeats the source signal in even increments, later in time, defined by the time setting. The feedback control increases / decreases the amount of repeats.	This works best with full, up-beat music like rock where the delay needs to cut through the mix.
2	Echo	This type of delay effect repeats the source signal twice. It has a characteristic of a double repeat like a voice reflecting off the walls of a canyon. The timing and amount of repeats are defined by the time and feedback settings.	Also known as Slap Back Echo, use it to make a vocal or guitar stand out in the mix without extra volume.
3	Slapback	This effect provides a single or double, relatively rapid delay of the original signal with minimal repeats through the feedback setting.	Slapback is generally used to mimic vocals – and sometimes drums – on '50s-era rock 'n roll.
4	Hall Reverb	This reverb is characterized by its large, spacious sound, long pre-delay and vibrant tone.	Adds life to acoustic instruments and vocals from solos to full-on symphonies and choirs.
5	Room Reverb	This preset features a medium sized room sound, with just enough enhancement of the lower mids to produce a warm tone.	Useful for any instrument or vocal source to sound like it's in an acoustic space that is like a recording studio. Try running the snare, horn section, or acoustic guitar on this one!
6	Plate Reverb	Plate reverbs emulate vintage mechanical reverberation that is generated with a metal plate. Its sound is characterized by lots of early reflections and no pre-delay.	Perfect for adding a long sustain to percussion like tambourine, hand-claps, and backup vocals.
7 8	Chorus 1 Chorus 2	These presets provide a soft, ethereal sweeping effect that is useful for thickening and for making a particular sound pop out of the mix.	Perfect for enhancement of electric and acoustic guitar and bass, or to add a dramatic effect to vocals, particularly group harmonies and choirs.
9	Flanger	The flange effect is a modulated delay with feedback (and shorter delay times than a chorus), which creates the characteristic “whooshing” sound often used to describe the flange sound.	Check out the electric rhythm guitar on the song “Barracuda” by Heart.
10	Delay + Reverb	Don't choose delay, don't choose reverb! Get the best of both worlds with effects preset #10!	Useful for bands that employ the alternative rock, shoegaze and/or experimental rock sound.
11	Delay + Chorus	Don't choose delay, don't choose chorus! Get the best of both worlds with effects preset #11!	Pink Floyd guitarist, David Gilmour, often used this effect in his setup.
12	Reverb + Chorus	Don't choose reverb, don't choose chorus! Get the best of both worlds with effects preset #12!	Really thicken things up with this preset. The chorus creates a slightly detuned version of the signal blended with the normal signal, while the reverb emulates the bouncing of sound waves across different-sized venues.

Delay

The preset display should now show the current parameters of the delay effect:

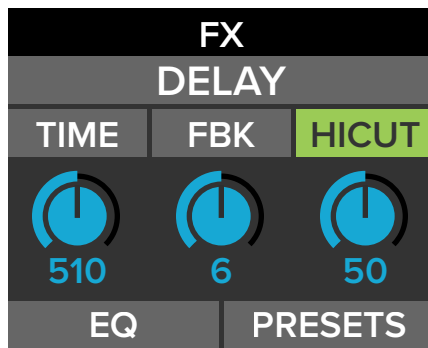
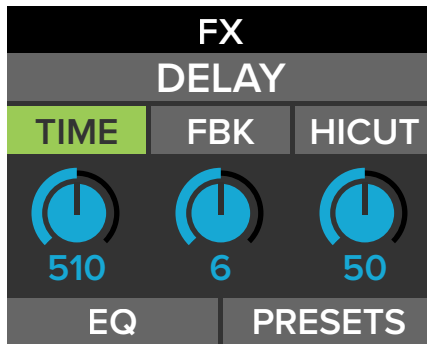

Delay allows adjustment of the delay effect. ProFXIO GO mixers come with three delays to choose from: delay, echo and slapback.

The delay parameters that may be changed on each include time, feedback and hi-cut. Additionally, each effect has an EQ section, as well as a spot to save and load custom FX via presets.

Rotate the Studio Command Control Knob between the three selections located above the virtual knobs. When time, feedback or hi-cut is highlighted, simply push the knob in to select the parameter.

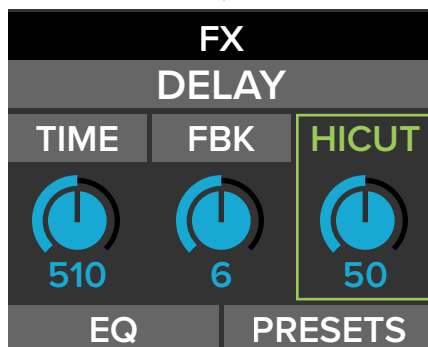

Notice how hi-cut is highlighted in the first screenshot to the left. But in the screenshot below it, hi-cut has been selected (by pressing in the Studio Command Control Knob), resulting in the text of the parameter and corresponding border turning green.

From here, rotate the knob again to tweak the selected parameter's value to your liking. Once a desired setting has been reached, push the knob in again to confirm.

Time – This knob sets the current delay time in milliseconds, from 20 ms to 1000 ms.

Feedback – This controls how much of the delayed signal is routed back to the input of the delay section to create multiple echoes. Each time the signal is fed back, the delayed signal becomes quieter (so the echo won't go on forever). It ranges from 0 to 13.

Hi Cut – This applies a low-pass filter to the delayed signal and rolls off the higher frequencies on the output. It ranges from 0 to 100.

FX EQ



Now let's take a look at the EQ section. As before, rotate the knob until EQ is highlighted, then push in to reveal the EQ screen.

The EQ parameters that may be changed here include frequency, width, gain, LPF and HPF. Now keep in mind that this is the EQ of the selected effect!

As before, rotate the Studio Command Control Knob between the five selections located above the virtual knobs. When frequency, width, gain, LPF or HPF is highlighted, simply push the knob in to select the parameter.



Notice how LPF is highlighted in the first screenshot to the left. But in the one below it, LPF has been selected (by pressing in the Studio Command Control Knob), resulting in the value of the parameter and corresponding border turning green.

From here, rotate the knob again to tweak the selected parameter's value to your liking. Once a desired setting has been reached, push the knob in again to confirm.

Frequency – This parameter's value determines the frequency of the selected effect, ranging from 400 Hz to 16.0 kHz.

Width [aka "Q"] – The Q control adjusts the bandwidth of a filter. However, the Q value itself is dimensionless; it has no unit of measurement. Some equalizers use the fractional bandwidth of the filter, measured in octaves, to express this parameter. The two parameters are inversely related; a high Q value corresponds to a small fractional bandwidth. The following table lists some equivalent Q and fractional bandwidth values. It ranges from 0.5 to 3.

Q	Bandwidth (Octave)
0.7	2
1.414	1
2.145	2/3
2.871	1/2

Gain – This parameter's value determines the amount of gain applied to the selected effect. It ranges from -8 dB to +8 dB.

LPF – Low-pass filters are utilized to cut out high frequencies. It ranges from 6.0 kHz to 18.0 kHz.

HPF – High-pass filters are utilized to cut out low frequencies. It ranges from 80 Hz to 600 Hz.

Before moving on to 'Presets' and 'Reset', let's take a quick peek at the parameters of delay, echo and slapback, as well as their EQ settings.

Delay Parameters and Values

Parameter	Low Value	High Value	Default	Increments
Time	20 ms	1000 ms	363 ms	±10 ms
Feedback	0	13	2	±1
Hi Cut	0	100	78	±1
EQ	-	-	-	-
Frequency	400 Hz	16.0 kHz	7.9 kHz	Variable
Width (Q)	0.5	3.0	0.5	±0.1
Gain	-8 dB	+8 dB	+1 dB	±1 dB
LPF	6.0 kHz	18.0 kHz	6.0 kHz	±0.1-0.2 kHz
HPF	80 Hz	600 Hz	120 Hz	±1-10 Hz

Echo Parameters and Values

Parameter	Low Value	High Value	Default	Increments
Time	140 ms	1000 ms	553 ms	±10 ms
Feedback	0	17	6	±1
Hi Cut	0	100	77	±1
EQ	-	-	-	-
Frequency	400 Hz	16.0 kHz	1.0 kHz	Variable
Width (Q)	0.5	3.0	2.0	±0.1
Gain	-8 dB	+8 dB	±0 dB	±1 dB
LPF	6.0 kHz	18.0 kHz	7.0 kHz	±0.1-0.2 kHz
HPF	80 Hz	600 Hz	100 Hz	±1-10 Hz

Slapback Parameters and Values

Parameter	Low Value	High Value	Default	Increments
Time	80 ms	400 ms	96 ms	±3-4 ms
Feedback	0	2	0	±1
Hi Cut	0	100	100	±1
EQ	-	-	-	-
Frequency	400 Hz	16.0 kHz	1.0 kHz	Variable
Width (Q)	0.5	3.0	2.0	±0.1
Gain	-8 dB	+8 dB	±0 dB	±1 dB
LPF	6.0 kHz	18.0 kHz	12.1 kHz	±0.1-0.2 kHz
HPF	80 Hz	600 Hz	80 Hz	±1-10 Hz

FX Presets

The presets section allows you to save up to six settings to memory that may be recalled at a later time. No more having to reset parameters upon every power-up!

As was done previously, simply rotate the Studio Command Control Knob until 'Presets' is highlighted (first screenshot below). Next, rotate the knob to switch between the six presets followed by pushing the knob in to select it (second screenshot below).

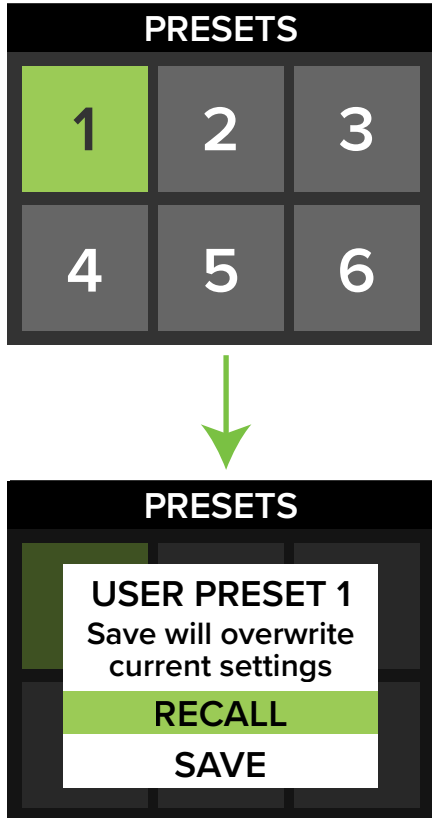

As one might suspect by now, rotating the knob switches between 'Recall' and 'Save' and pushing the knob in chooses the currently highlighted selection.



Save – Select this to save the current settings to the corresponding preset.

Please be aware that the new settings will replace the currently saved settings.

Recall – Select this to recall the settings of the corresponding preset.

FX EQ Reset

A few pages ago, we were looking at the FX EQ section. In addition to the changeable parameters – frequency, width, gain, LPF and HPF – a sixth option (located in the lower-right corner) may also be accessed and selected: Reset

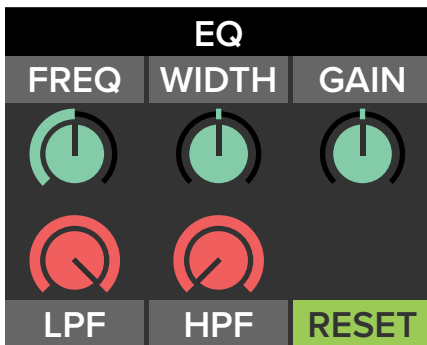

Once 'Reset' is highlighted, push the control knob in to reset all EQ settings. It is a convenient way to start with a fresh slate.

Resetting any FX EQ results in the following parameter values:

- Frequency – 1.0 kHz
- Width – 2.0
- Gain – ± 0 dB
- LPF – 18.0 kHz
- HPF – 80 Hz

NOTE Resetting the FX EQ and doing a factory reset (see page 25) are not the same thing and will result in different settings.

Now that you're familiar with how to select an effect and tweak the parameters' values to your liking, we're going to look at the remaining effects, their settings and their low, high and default values, starting with the three reverbs (Hall, Room and Plate).

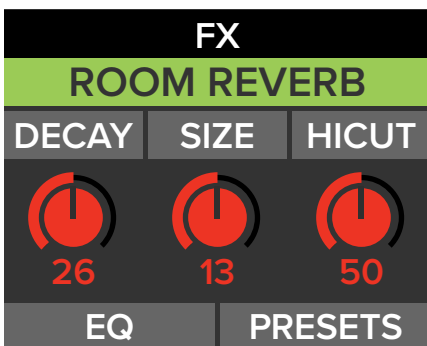

Decay – This knob represents the decay time of the reverb. The range will vary depending on the reverb chosen.

Size – This knob represents the amount of desired reverb (or “the size of the room”). While the range will vary depending on the reverb chosen, 0 means no reverb and fully clockwise is max reverb.

Hi Cut – This applies a low-pass filter to the delayed signal and rolls off the higher frequencies on the output. It ranges from 0 to 100.

Hall Reverb Parameters and Values

Parameter	Low Value	High Value	Default	Increments
Decay	0	60	15	±1
Size	0	15	12	±1
Hi Cut	0	100	0	±1
EQ	-	-	-	-
Frequency	400 Hz	16.0 kHz	1.0 kHz	Variable
Width (Q)	0.5	3.0	2.0	±0.1
Gain	-8 dB	+8 dB	+0 dB	±1 dB
LPF	6.0 kHz	18.0 kHz	8.7 kHz	±0.1-0.2 kHz
HPF	80 Hz	600 Hz	132 Hz	±1-10 Hz

Room Reverb Parameters and Values

Parameter	Low Value	High Value	Default	Increments
Decay	0	52	3	±1
Size	0	25	12	±1
Hi Cut	0	100	0	±1
EQ	-	-	-	-
Frequency	400 Hz	16.0 kHz	1.0 kHz	Variable
Width (Q)	0.5	3.0	2.0	±0.1
Gain	-8 dB	+8 dB	+0 dB	±1 dB
LPF	6.0 kHz	18.0 kHz	13.3 kHz	±0.1-0.2 kHz
HPF	80 Hz	600 Hz	190 Hz	±1-10 Hz

Plate Reverb Parameters and Values

Parameter	Low Value	High Value	Default	Increments
Decay	0	65	35	±1
Size	0	40	35	±1
Hi Cut	0	100	20	±1
EQ	-	-	-	-
Frequency	400 Hz	16.0 kHz	400 Hz	Variable
Width (Q)	0.5	3.0	2.5	±0.1
Gain	-8 dB	+8 dB	+8 dB	±1 dB
LPF	6.0 kHz	18.0 kHz	8.2 kHz	±0.1-0.2 kHz
HPF	80 Hz	600 Hz	80 Hz	±1-10 Hz

Now a look at the three modulation effects (Chorus 1, Chorus 2 and Flanger).

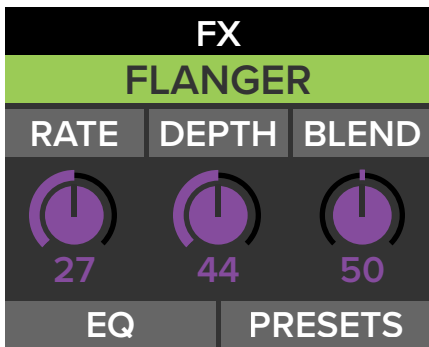

Rate – This knob sets the speed of the delay modulation. The range will vary depending on the effect chosen.

Depth – This knob sets the depth of the delay modulation, from 1 to 10. The range will vary depending on the effect chosen.

Blend – The Blend knob essentially works as a level control in that you determine how much the sound effect dominates the mix.

Chorus 1 Parameters and Values

Parameter	Low Value	High Value	Default	Increments
Rate	0	54	12	±1
Depth	16	73	28	±1
Blend	0	100	59	±1
EQ	-	-	-	-
Frequency	400 Hz	16.0 kHz	1.0 kHz	Variable
Width (Q)	0.5	3.0	2.0	±0.1
Gain	-8 dB	+8 dB	+0 dB	±1 dB
LPF	6.0 kHz	18.0 kHz	10.0 kHz	±0.1-0.2 kHz
HPF	80 Hz	600 Hz	120 Hz	±1-10 Hz

Chorus 2 Parameters and Values

Parameter	Low Value	High Value	Default	Increments
Rate	16	93	16	±1
Depth	30	150	36	±1
Blend	0	100	100	±1
EQ	-	-	-	-
Frequency	400 Hz	16.0 kHz	3.0 kHz	Variable
Width (Q)	0.5	3.0	3.0	±0.1
Gain	-8 dB	+8 dB	-8 dB	±1 dB
LPF	6.0 kHz	18.0 kHz	8.7 kHz	±0.1-0.2 kHz
HPF	80 Hz	600 Hz	334 Hz	±1-10 Hz

Flanger Parameters and Values

Parameter	Low Value	High Value	Default	Increments
Rate	0	100	10	±1
Depth	10	150	62	±1
Blend	0	100	100	±1
EQ	-	-	-	-
Frequency	400 Hz	16.0 kHz	7.6 kHz	Variable
Width (Q)	0.5	3.0	2.0	±0.1
Gain	-8 dB	+8 dB	-1 dB	±1 dB
LPF	6.0 kHz	18.0 kHz	18.0 kHz	±0.1-0.2 kHz
HPF	80 Hz	600 Hz	90 Hz	±1-10 Hz



The rate (Hz) and depth (ms) determine how many cycles per second the chosen effect oscillates. However, the rate and depth of Chorus 1, Chorus 2 and Flanger is expressed as 0.1x Hz / ms which translates the value that the processor utilizes. An easy way to understand the value is to take the number below the virtual knob and “move” the decimal one point to the left (or multiply by 0.1).

For example, if rate is displayed as 37, then it's really 3.7 Hz.

Lastly, onto the final three multi-purpose effects (Delay + Reverb, Delay + Chorus, and Reverb + Chorus).

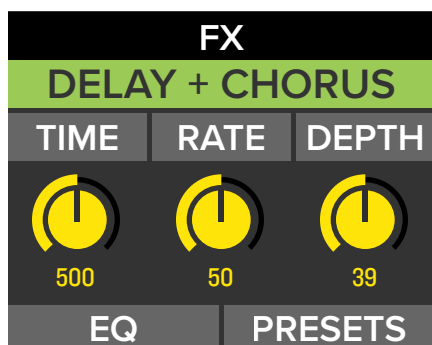

Time – This knob sets the current delay time in milliseconds, from 20 ms to 1000 ms.

Rate – This knob sets the speed of the modulation. The range will vary depending on the effect chosen.

Depth – This knob sets the depth of the delay modulation. The range will vary depending on the effect chosen.

Decay – This knob represents the decay time of the reverb, ranging from 0 to 60.

Size – This knob represents the amount of desired reverb (or “the size of the room”), ranging from 0 (no reverb) to 15 (max reverb).

Delay + Reverb Parameters and Values

Parameter	Low Value	High Value	Default	Increments
Time	20 ms	1000 ms	196 ms	±9-10 ms
Rate	16	73	26	±1
Depth	0	100	8	±1
EQ	–	–	–	–
Frequency	400 Hz	16.0 kHz	6.8 kHz	Variable
Width (Q)	0.5	3.0	2.1	±0.1
Gain	–8 dB	+8 dB	+2 dB	±1 dB
LPF	6.0 kHz	18.0 kHz	12.6 kHz	±0.1-0.2 kHz
HPF	80 Hz	600 Hz	88 Hz	±1-10 Hz

Delay + Chorus Parameters and Values

Parameter	Low Value	High Value	Default	Increments
Time	20 ms	1000 ms	196 ms	±9-10 ms
Rate	0	73	12	±1
Depth	16	100	40	±1
EQ	–	–	–	–
Frequency	400 Hz	16.0 kHz	1.0 kHz	Variable
Width (Q)	0.5	3.0	2.0	±0.1
Gain	–8 dB	+8 dB	±0 dB	±1 dB
LPF	6.0 kHz	18.0 kHz	6.0 kHz	±0.1-0.2 kHz
HPF	80 Hz	600 Hz	80 Hz	±1-10 Hz

Reverb + Chorus Parameters and Values

Parameter	Low Value	High Value	Default	Increments
Decay	0	60	10	±1
Size	0	15	6	±1
Rate	0	54	33	±1
EQ	-	-	-	-
Frequency	400 Hz	16.0 kHz	415 Hz	Variable
Width (Q)	0.5	3.0	2.0	±0.1
Gain	-8 dB	+8 dB	-5 dB	±1 dB
LPF	6.0 kHz	18.0 kHz	10.0 kHz	±0.1-0.2 kHz
HPF	80 Hz	600 Hz	108 Hz	±1-10 Hz



The rate (Hz) and depth (ms) determine how many cycles per second the chosen effect oscillates. However, the rate and depth of the two chorus modulation effects is expressed as 0.1x Hz / ms which translates the value that the processor utilizes. An easy way to understand the value is to take the number below the virtual knob and “move” the decimal one point to the left (or multiply by 0.1). For example, if rate is displayed as 37, then it’s really 3.7 Hz.

Outdoors

...and this would be my personal favorite feature of the ProFXIO GO: OUTDOORS. That’s right, with 21st century technology, we have figured out a way to “stuff” extra features into our mixers! And with this being a portable, battery-powered mixer, we’re going to take it camping with us!



The ProFXIO GO mixer allows you to access it for all kinds of information. This could be anything from hiking trail locations, hunting/fishing/bird watching locations, and camping recipes. Furthermore, they are listed in day time and night time activities. In the day time activities example above, we have selected Gobblers Knob Trail for hiking followed by a bird watching excursion (via H•F•B-ing = hunting, fishing, birding), specifically the violet-green swallow. This trail and these birds may be found in Mount Rainier National Park in Washington State. Prior to heading out, though, we made (and ate) some breakfast burritos using the recipe found on the ProFXIO GO mixer.



Hunting is not allowed inside of Mount Rainier National Park, but there is plenty in the surrounding areas. Please refer to the local campground rules and regulations of whether hunting and/or fishing is allowed.

Underneath the hood – aka inside the mixer – is a GPS tracking device. This way, the mixer knows your location and can easily display the nearby hiking trails, as well as the closest hunting/fishing/birding locations in your region.

As you might expect, we cannot list the parameters and values of every single hiking trail and hunting/fishing/birding location since they are essentially endless. It is a portable, battery-powered mixer and expects to hit the road! Best to prepare BEFORE leaving, then utilizing the mixer to hone in on details once there.

That's not all, though! That's right, we just showed you day time activities, but sleeping isn't the only night time activity. No! You can also gather 'round the campfire with your better half, other family members, friends, nearby campers, and whoever else you want to join in for an enthusiastic round of camping karaoke. In the example below, someone is belting out the Johnny Cash classic, *Ring of Fire*... around a campfire, no less. Yes, pun very much intended. Plus, Johnny Cash rules!



If it's not your turn to sing, then check out the camping recipes for some good meals to eat while you wait. Veggie kabobs is displayed in the example above, but if you went hunting or fishing during the day, rotate and push the knob to display those recipes, too!

Once the karaoke battle has concluded and the winner has received their trophy, feel free to check out the stars in the sky above. Yes, the ProFX10 GO works as a sky guide, as well... a map of the stars! The Delta Aquariids are meteor showers that may be viewed from Mount Rainier.



As many as 20 meteors per hour may occur in late July!

Whether it's day time or night time, rotate the knob until the selection you desire is displayed, then push to select.

Recording Mode



The ProFX10 GO mixer was designed with you, the recording artist, in mind. Press the REC button to toggle between the three recording modes. The currently selected choice will illuminate green.

The three modes –and what they mean – are listed below:

Standard – Captures a complete recording of the main mix to computer, including GigFX+ effects and tone-shaping EQ.

Loop Back – Includes computer audio to the recording.

This is great for video game streams or playing music over backing tracks, for example.

Interface – Sends untouched audio from channels 1 and 2 directly to the computer – without effects – for the cleanest recording possible.

Battery Replacement

The Lithium-Ion Battery allows you to use a ProFX10 GO without the need to be plugged in or wasting money on expensive batteries. This is great for mobile gigging, live streaming, and more!



SAFETY FIRST: Before installing and using this product, please read these instructions carefully.

Failure to follow the precautions may result in damage, injury, or even death.

1. WARNING: The battery (battery or batteries or battery pack) shall not be exposed to excessive heat such as sunshine, fire or the like.

2. CAUTION: Danger of explosion if battery is incorrectly replaced. Replace only with the same or equivalent type.

3. No open flame sources, such as lighted candles, should be placed on the apparatus.

WARNING: When installing this product, always respect the safety standard.

Do not install the product in any way that is not described in these instructions.

BATTERY / COVER REMOVAL INSTRUCTIONS:

Unplug and power off the ProFX10 GO and set it upside down on a soft, flat surface. Bottoms up!

Using a finger, push the green tab towards the front of the mixer. It will unlock and “pop” up as seen to the left.

Remove the battery compartment cover and set it aside, keeping in mind the position it was removed in.



As seen to the right, the battery has been removed from the ProFXIO GO.

The easiest way to remove the battery is by using a fingernail or flathead screwdriver.

There is a small cutout on the battery on the green tab side of the mixer.

Get in there and remove the battery from captivity by lifting it straight up and out to freedom!



BATTERY INSTALLATION INSTRUCTIONS:

Once the battery cover and battery have been removed and set aside, it's time to insert a different one.



NOTE: Do not force the battery into place. There is only one way it fits and there should be no resistance during installation.

If you zoom in really closely in the photo above-right – the green encircled area in particular – a power connector is located from where the battery was removed. Line up the power connector of the battery (the green encircled area as seen to the left) with the power connector of ProFXIO GO and slowly release. Again, this is an easy process; no force is necessary. See the battery in mixer photo on the previous page if any questions arise.

Replace the battery cover and lock it to the ProFXIO GO by pushing down on the cover until the tab 'clicks'.



When not in use, a spare battery (purchased separately) may be charged via USB cable. The USB-C side of the cable connects to the battery and the other side into a standard USB connector. The battery will also charge while inside a plugged-in ProFXIO GO.

These are the most important battery specs to look for:

- 11.1V, 5200mAh 57.72Wh, 24V
- **Size:** no larger than 5.0 in (127 mm) x 3.0 in (76 mm) x 0.89 in (22 mm)

BATTERY CHARGING INSTRUCTIONS:

The features displayed in the green square (as seen in the picture above) serve a dual purpose. One side of the removable battery is a USB-C connector. This is another way to charge the battery (in addition to charging while inside the mixer)! Next to the USB-C connector is a small circle. This is an LED that displays the battery status as seen below. This same text is silk-screened on the GB-10 battery itself.



Hookup Diagrams

Hookup Diagrams > Typical Live Sound System

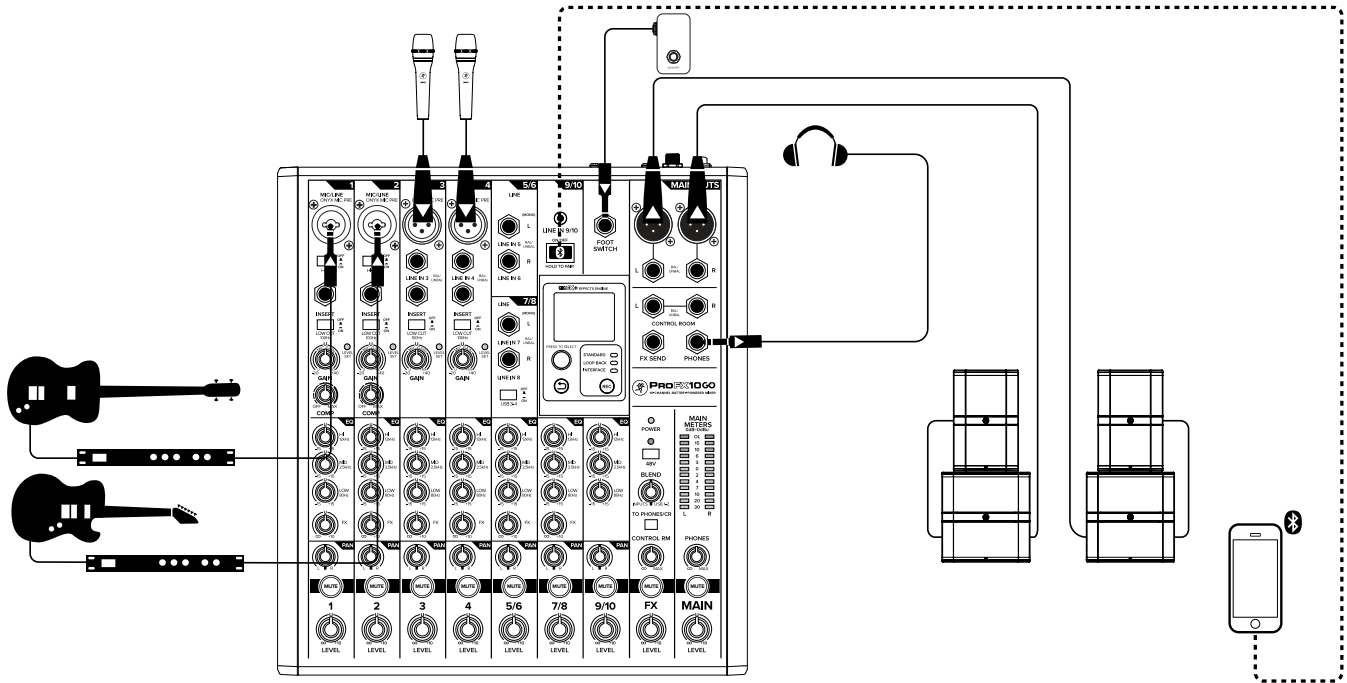

This diagram shows a guitar and bass attached to the channel 1 and 2 line-level inputs, each via a mono effects processor. The Hi-Z switch is engaged on both channels. A microphone is connected to the following two channels and will handle lead and back-up vocal duties. A phone is connected to the last channel on the board via Bluetooth.

DRM18S powered subwoofers are connected to the left and right main outputs. Those are then connected to a pair of SRM215 | V-Class loudspeakers to complete the PA. Headphones are used for monitoring and a footswitch allows you to mute/unmute the internal effects as desired.

It's not shown, but a laptop may connect to the USB port on the rear panel of the mixer. It allows the performance to be recorded to a DAW, as well as playback from the computer to the main mix.

Hookup Diagrams > Typical Recording System

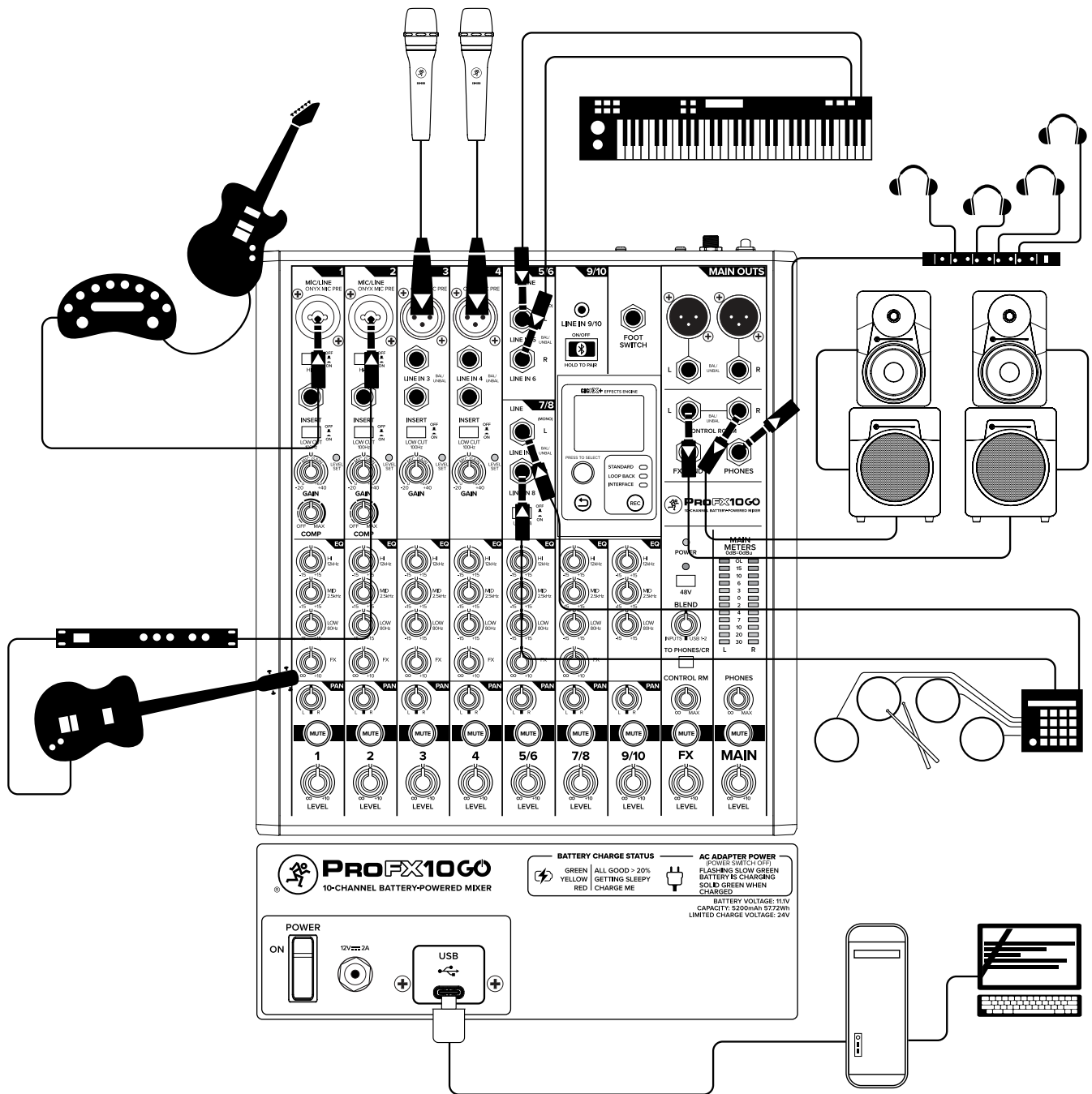

Like the previous hookup diagram, this one also starts with a guitar and bass attached to the channel 1 and 2 line-level inputs, each via a mono effects processor. The Hi-Z switch is engaged on both channels. Microphones are attached to channels 3 and 4, a keyboard to stereo channels 5/6, and an electronic drum kit to stereo channels 7/8.

MR Series powered reference subwoofers and monitors are connected to the left and right control room outputs for careful and accurate monitoring of the performance. Headphones connected to a head amplifier which is then connected to the phones output. These headphones are available for the talent to utilize when tracking.

A desktop computer connects to the USB port to record the mix to the DAW, as well as playback from the DAW.

Hookup Diagrams > Camping

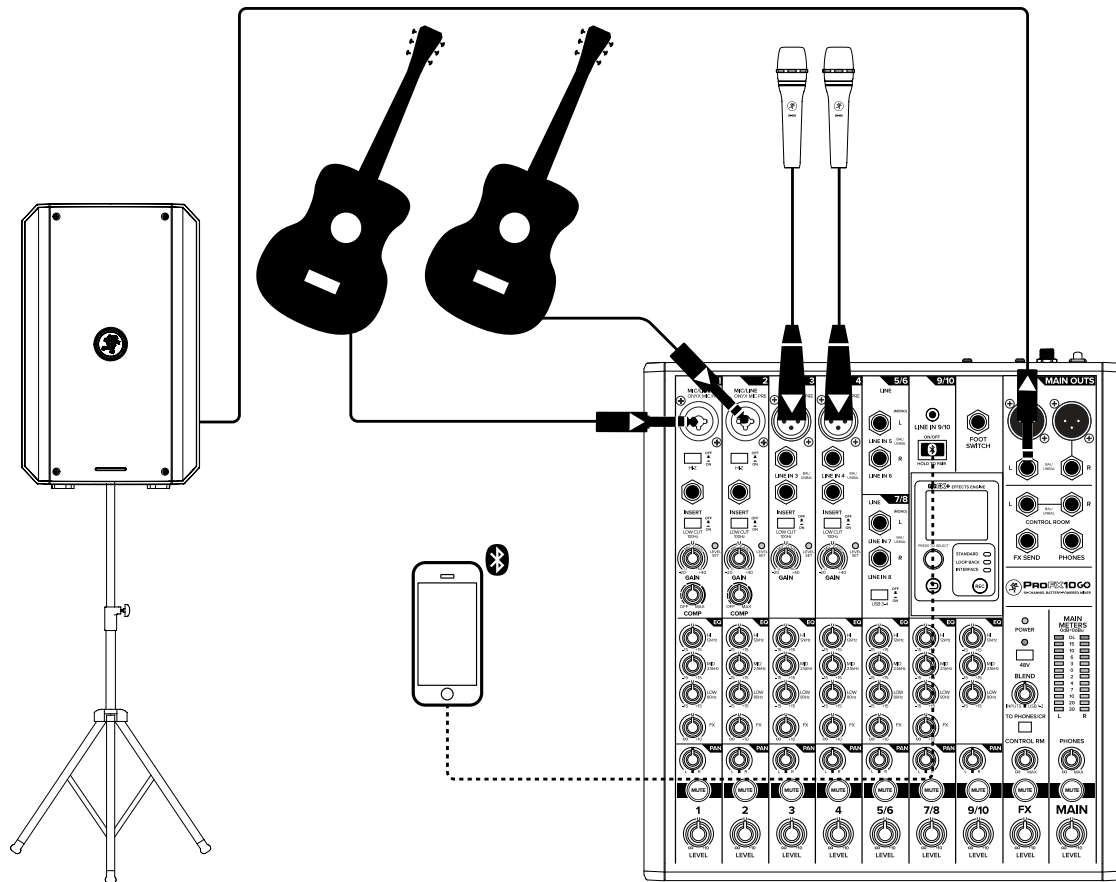
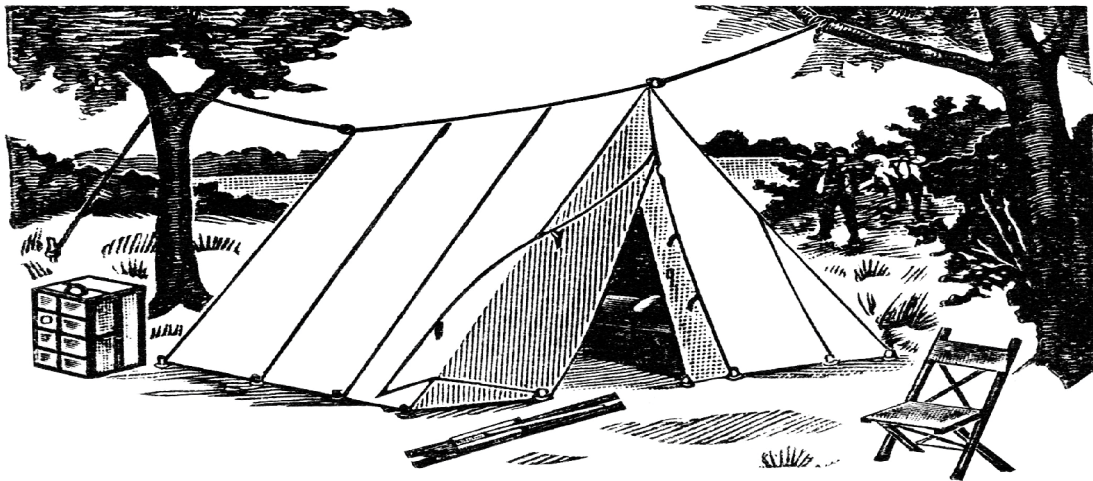

A family loves to go camping... but they also love to play music together. With Mackie ProFXIO GO, both are a possibility!

After pitching a tent and grabbing firewood – but before snipe hunting – we would like to get everything connected. Here we have two guitars plugged into the channel 1 and channel 2 inputs. The Hi-Z switch should be engaged on both channels. Mackie EM-89 microphones are connected to channels 3 and 4 so their gorgeous voices will be heard. A phone is connected via Bluetooth to play backing tracks, beats, or whatever else you decide!

The main left output is connected to the input of a Thump GO loudspeaker – which may also be powered via battery – so the glorious tunes may be enjoyed by all around the campfire.

When you're finished playing guitar, remove them from the inputs and replace them with two mics (making sure the Hi-Z switch is disengaged). The phone plays whatever songs are chosen and people can take turns singing along to their favorite songs. We call this campaoke. And it's super-fun!

Appendix A : Service Information

Troubleshooting

If you think your Mackie product has a problem, please check out the following troubleshooting tips and do your best to confirm the problem. Visit the Support section of our website (www.mackie.com) to get some ideas or contact our technical support heroes. You may find the answer to the problem without having to send your Mackie product away.

Here are some useful tips that could correct any of the issues outlined below (or possibly any other issue that we haven't yet discovered):

Level setting procedure. If you are having any sound (or non-sound) issues, try following the level setting procedure [page 8] to verify that all of the volume controls in the system are properly adjusted.

There are no user serviceable parts. If none of these tips work, please refer to "Repair" on the next page to find out how to proceed.

No Power

- Our favorite question. Is it plugged in (whether by power cord or battery)?
Make sure the AC outlet is live [check with a tester or lamp].
- Our favorite follow-up question. If using a battery, is it fully charged? Are you sure?!
- Our second favorite question. Is the rear panel power switch in the ON position? If not, try turning it on.
- Make sure the line cord is securely seated in the line cord socket and plugged all the way into the AC outlet.
- Is the power LED on the top panel illuminated? If not, make sure the AC outlet is live. If so, refer to "No sound" below.
- The internal AC line fuse may be blown. This is not a user serviceable part.
If you suspect the AC line fuse is blown, please see the "Repair" section next.
- Are all the lights out in town? If so, contact the local power company to get power restored.

No Sound

- Are all the connections good and sound? Make sure all of the connecting cables work and are securely connected at both ends. Try the same source signal in another channel, set up exactly like the suspect channel. Make sure the master volume level is turned up sufficiently to drive the inputs of the speakers.
- Is the level knob for the input source turned all the way down? Verify that all the volume controls in the system are properly adjusted. Look at the level set LEDs and meters to ensure that the mixer is receiving a signal.
- Make sure the input source is not muted or has a processor loop engaged. If you find something like this, make sure the level is turned down before disengaging the offending switch.
- Is the main level turned up?
- Unplug anything from the other line-level outputs, such as monitor out, just in case one of the external pieces has a problem.
- Make sure that you are not overdriving the amplifiers. Check the loudspeaker average load impedance is not less than the minimum the amplifier can handle. Check the speaker wiring.
- Is the signal source powered on? Is it working (and making union scale)?

Noise / Hum

- Are the EQs set to reasonable levels?
- Are you using unbalanced cables? Swap them out with balanced cables to see if that fixes the problem.
- Try the same source signal in another channel, set up exactly like the suspect channel.
- Try disconnecting the cable connected to the input jack. If the noise disappears, it could be a “ground loop,” rather than a problem with the mixer.
- Turn the input gains down one-by-one. If the offending noise disappears, it’s either that input or whatever is plugged into it. If you unplug the whatever-is-plugged-into-it and turn the input gain back up and the noise is gone, it’s from your whatever.
- Is phantom power required for the microphone?
- Whenever possible, plug all the audio equipment’s line cords into outlets which share a common ground. The distance between the outlets and the common ground should be as short as possible.
- Make sure none of the signal cables are routed near AC cables, power transformers, or other EMI-inducing devices.
- Is there a light dimmer or other SCR-based device on the same AC circuit as the mixer?
Use an AC line filter or plug it into a different AC circuit.

Other Issues

- Bluetooth Blues?
 - Restart the Bluetooth device. Completely power it down, then power it back up.
 - Restart the mixer. A simple reboot can sometimes work great wonders.
- Using a Windows-driven computer and need to install the Mackie USB Driver?
 - Go to mackie.com and look for the file named ‘USB Driver Installation Instructions’.
- Need answers about ASIO?
 - There is a lot of great information here, including ASIO driver downloads, FAQs, troubleshooting, a forum and more! Please review before calling Technical Support:
 - o <http://www.asio4all.org/>
- Other issues?
 - Please email or call Technical Support if you are having any other issue not listed here:
 - o mackie.com/support-contact
 - o 1-800-898-3211

Microphone Stand

The bottom panel of the ProFXIO GO has three non-threaded holes that allow it to be fitted with an optional microphone stand adapter. This lets you support the mixer on a standard mic stand, and adjust its height and level to whatever suits your strangely-complex set of preferences.



1. Order the Atlas AD-11B mic stand adapter available from many a fine music store. (It is made and distributed by Atlas Sound.)
2. Use three Trilobular thread rolling screws 6-32 x 1/4" long to secure the adapter to the bottom of the mixer [see below].



Do not use screws longer than 1/4" as these could damage the circuit boards.
Do not use screws shorter than 1/4" or the adapter will not be securely fixed to the mixer.

Repair

For warranty service, refer to the warranty information on page 53.

Non-warranty service for Mackie products is available at a factory-authorized service center. To locate the nearest service center, visit www.mackie.com, click "Support" and select "Service Center Locator". Service for Mackie products living outside the United States can be obtained through local dealers or distributors.

If you do not have access to our website, you can call our Tech Support department at 1-800-898-3211, Monday-Friday during normal business hours, Pacific Time, to explain the problem. Tech Support will tell you where the nearest factory-authorized service center is located in your area.

Appendix B : Technical Information

Specifications

Noise Characteristics

Equivalent Input Noise (EIN) (150 Ω Source Impedance, 20 Hz to 20 kHz)

Mic in to Insert Send out, max gain: -126 dBu

Residual Output Noise

All outputs, master levels off, all channel levels off: -95 dBu

All outputs, master levels unity, one channel level unity: -80 dBu

Frequency Response

Mic input to any output (gain at unity, +0 dB / -1 dB): 20 Hz to 30 kHz

Distortion (THD+N)

(22 Hz to 80 kHz bandwidth)

Mic in to Main Out (+4 dBu output): <0.02%

Attenuation and Crosstalk

Adjacent Inputs @1 kHz: -90 dB

Inputs to Outputs @1 kHz: -80 dB

Fader Off @1 kHz: -75 dB

Mute Switch @ 1 kHz : -90 dB

Common Mode Rejection Ratio (CMRR)

Mic in to Main out, max gain, 1 kHz: 70 dB

Maximum Levels

All inputs: +22 dBu

Main Mix XLR: +28 dBu

All other outputs: +22 dBu

Impedances

Mic in: 3.3 k Ω

Channel Insert Return: 10 k Ω

All other inputs: \geq 20 k Ω

Phones out: 25 Ω

All other outputs: 120 Ω Unbalanced,
240 Ω Balanced

Equalization

Low:±15 dB @ 80 Hz
Mid: ±15 dB @ 2.5 kHz
High: ±15 dB @ 12 kHz
Low Cut Filter:.....18 dB/octave @ 100 Hz

Maximum Voltage Gain (EQ Flat)

Mic Input Channel to...

Insert Output:..... 60 dB
1/4" Main Output: 80 dB
XLR Main Output:..... 86 dB

Mono Line Input Channel to...

Insert Output:..... 40 dB
1/4" Main Output: 60 dB
XLR Main Output:..... 66 dB

Stereo Line Input Channel to...

1/4" Main Output: 20 dB
XLR Main Output:..... 26 dB

1/8" Input to...

1/4" Main Output: 40 dB
XLR Main Output:..... 46 dB

USB Input to...

XLR Main Output:..... 46 dB

Digital Effects

Number of Presets: 12

Meters

Main L/R Mix – Two columns of 12 segments each:..... OL, +15, +10, +6, +3, 0 (0 dBu), -2, -4, -7, -10, -20, -30

USB

Format: USB 2.0
I/O: 1 Stereo Input, 2 Stereo Outputs
A/D/A: 24-bit, 44.1 kHz, 48 kHz, 96 kHz, 192 kHz

Phantom Power

48 VDC to all Mic channels simultaneously

Power Requirements

Power Connector: 12V  2A Class I Hard-Wired Wall Mount Adapter [Output]
100VAC–240VAC, 50–60 Hz, 0.8A [Input]

Battery Type: Lithium Ion

Battery Technology: 11.1V, 5200mAh 57.72Wh, 24V

Battery Life: Up to 8 hours

Operating Temperature: 0–40° C // 32–104° F

Dimensions

PROFXIO GO

Size (H x W x D): 3.8 x 10.6 x 11.5 in
97 x 269 x 292 mm

Weight: 5.9 lb
2.7 kg

GB-10

Size (H x W x D): 5.0 x 3.0 x 0.89 in
127 x 76 x 22 mm

Weight: 0.75 lb
0.34 kg

Options

ProFX10 GO Carry Bag: P/N 2057398

GB-10 Battery: P/N 2058458

About

Part Number, Rev and Date: SW1481, Rev A, January 2025

LOUD Audio, LLC. is always striving to improve our products by incorporating new and improved materials, components, and manufacturing methods. Therefore, we reserve the right to change these specifications at any time without notice. The "Running Man" is a registered trademark of LOUD Audio, LLC. All other brand names mentioned are trademarks or registered trademarks of their respective holders, and are hereby acknowledged.

Please check our website for any updates to this Owner's Manual: www.mackie.com.
©2025 LOUD Audio, LLC. All right All right All rights reserved.

ProFX10 GO Dimensions

10.6 in / 269 mm

11.5 in / 292 mm



3.8 in / 97 mm



Weight
5.9 lb / 2.7 kg



ProFX10 GO Block Diagram

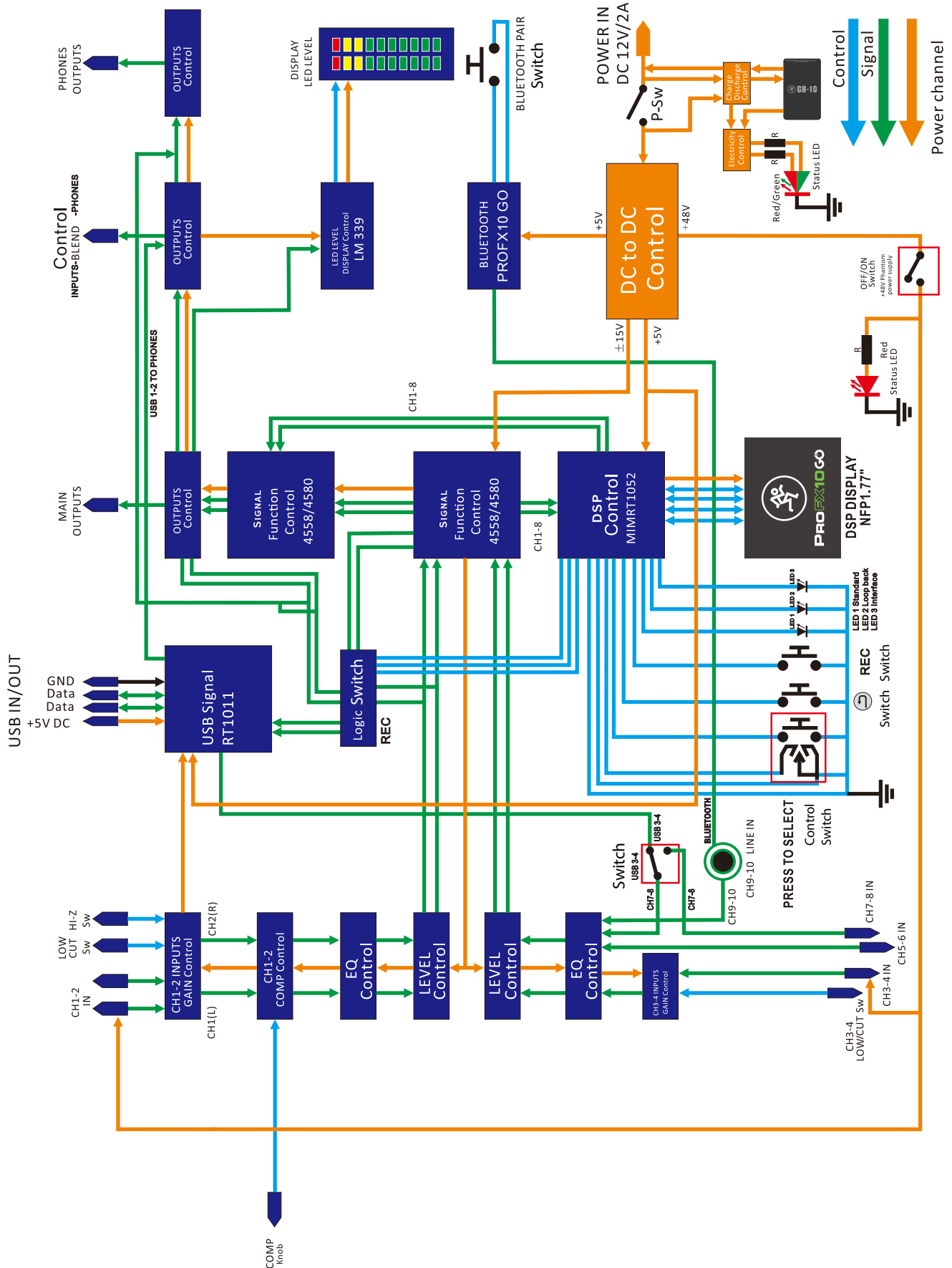

ProFX10 GO Track Sheet

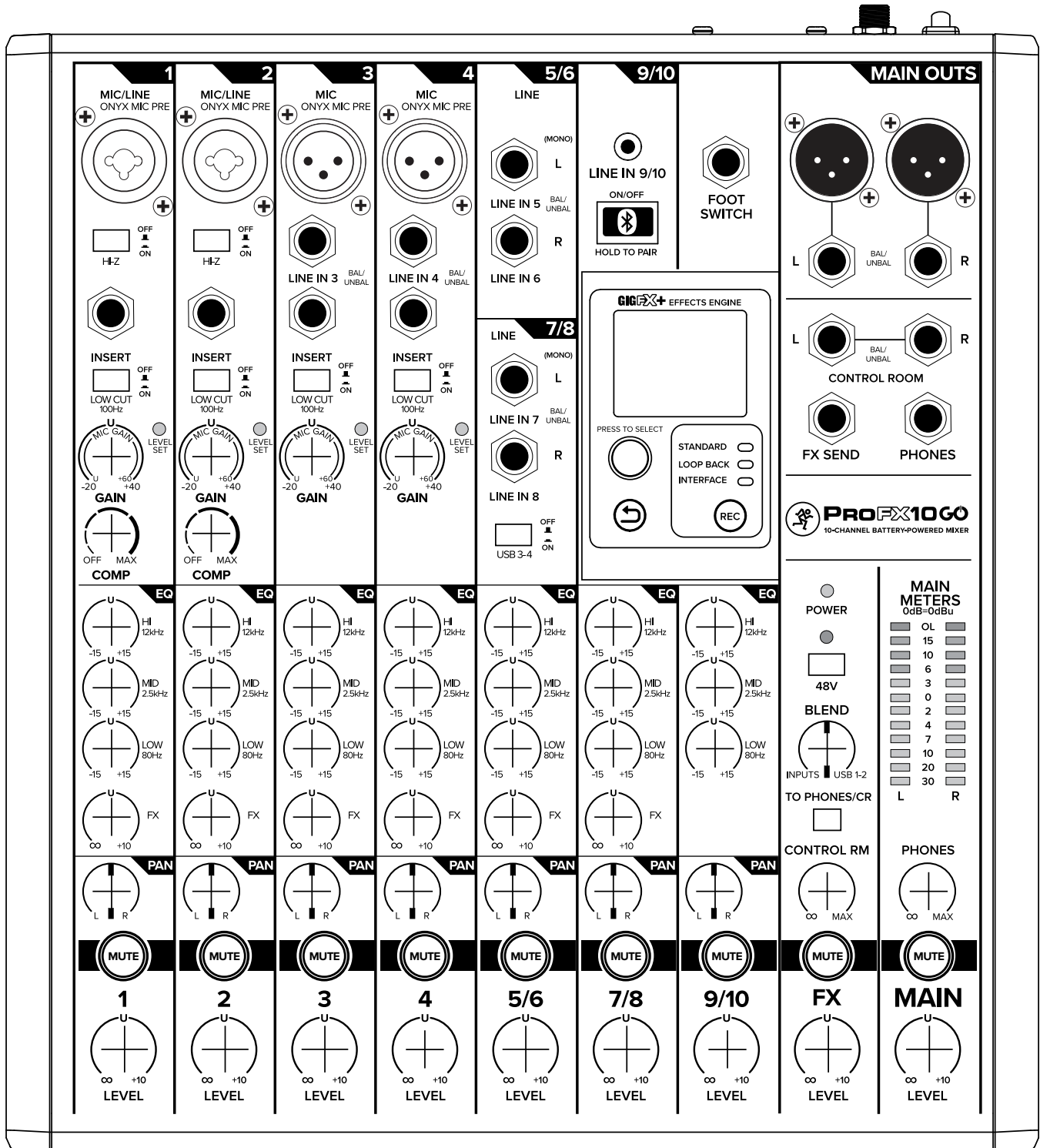

Appendix C: USB 3/4 Return Setup

Introduction

The ProFXIO GO mixer allows you to send audio from the computer into either the USB 1/2 Blend Mix or the 3/4 Main Mix. USB 1/2 is most useful for overdubbing when recording, while 3/4 is typically used for backing tracks, streaming or game audio.

When connected to a computer, the ProFXIO GO defaults to USB 1/2. To change this to USB 3/4, the computer's settings will need to be changed. Here we cover basic Windows and Mac setup applications that use the system's audio settings.



Some DAWs and other streaming applications have their own settings that may override system settings. If so, please review their documentation on how to make changes to the DAW / app.

Windows

1. Download the USB driver from the Mackie website.
2. Follow the installation instructions to install the driver.
3. Right-click on the speaker icon located on the task bar.
4. Select Sound Settings.
5. Under "Choose Your Output Device", select ProFXIO GO 3-4 from the dropdown menu.
6. On the mixer, be sure the USB 3/4 button is engaged (down) on the second-to-last channel.
7. Turn up the channel fader to unity, then slowly turn up the main mix fader.

You will know this worked if the main meters illuminate and you hear PC audio through the device connected to the main outputs.

Mac

A driver download is not necessary on a Mac. However, some parameters will still need to be changed within macOS.

1. Open the Audio MIDI Setup app using the Spotlight search (Command + Spacebar).
2. Right-click on the device and select the ProFXIO GO mixer in "Use This Device For Sound Input", as well as "Use This Device For Sound Output".
3. Select the 'Configure Speakers' button and be sure it is set to 'Stereo'.
4. Change the Left and Right options to Analog 3 and 4, then tap 'Apply'.
5. On the mixer, be sure the USB 3/4 button is engaged (down) on the second-to-last channel.
6. Turn up the channel fader to unity, then slowly turn up the main mix fader.

You will know this worked if the main meters illuminate and you hear PC audio through the device connected to the main outputs.

Warranty Statement

Please keep your sales receipt in a safe place.

This Limited Product Warranty ("Product Warranty") is provided by LOUD Audio, LLC. ("LOUD") and is applicable to products purchased in the United States or Canada through a LOUD-authorized reseller or dealer. The Product Warranty will not extend to anyone other than the original purchaser of the product (hereinafter, "Customer," "you" or "your").

For products purchased outside the U.S. or Canada, please visit www.mackie.com/warranty to find contact information for your local distributor, and information on any warranty coverage provided by the distributor in your local market.

LOUD warrants to Customer that the product will be free from defects in materials and workmanship under normal use during the Warranty Period. If the product fails to conform to the warranty then LOUD or its authorized service representative will at its option, either repair or replace any such nonconforming product, provided that Customer gives notice of the noncompliance within the Warranty Period to the Company at: www.mackie.com/support or by calling LOUD technical support at 1.800.898.3211 (toll-free in the U.S. and Canada) during normal business hours Pacific Time, excluding weekends or LOUD holidays. Please retain the original dated sales receipt as evidence of the date of purchase. You will need it to obtain any warranty service.

For full terms and conditions, as well as the specific duration of the Warranty for this product, please visit www.mackie.com/warranty.

The Product Warranty, together with your invoice or receipt, and the terms and conditions located at www.mackie.com/warranty constitutes the entire agreement, and supersedes any and all prior agreements between LOUD and Customer related to the subject matter hereof. No amendment, modification or waiver of any of the provisions of this Product Warranty will be valid unless set forth in a written instrument signed by the party to be bound thereby.



19820 North Creek Parkway #201, Bothell, WA 98011 • USA
Phone: 425.487.4333 • Toll-free: 800.898.3211
Fax: 425.487.4337 • www.mackie.com

